

podis®

FLEXIBLE SYSTEM

Decentralized Automation.

HELLO WIELAND ELECTRIC

Tradition and innovation - Wieland is representing the synergy of these two guiding principles for more than 100 years.

At Wieland Electric, we are proud to be the world market leader in electrical connections, and have been focusing on safe and innovative technologies since our founding. The beginnings of our success lie in the legendary Wieland Clamp, the first-ever safe electrical connector. Since then, innovation has pushed us to develop safer and more efficient ways to electrify the world.

Expanding from a component-only manufacturer, we are now one of the leading suppliers of innovative, future-oriented, and complete electrical solutions. We divide our focus into two main areas, Building and Industry. Our Building Solutions focus on decentralized power distribution and pluggable connections in all kinds of architectures and infrastructures. From in-store displays and lighting to hospitals and airports, and any structure in between – you build it, we power it! Our Industry Solutions center around functional safety for machines, industrial networking (IIoT and VPN), and power distribution. At Wieland, we keep your productivity going in mechanical engineering, wind power, material handling, HVAC, and many other industries.

We are at our customers' side in every step of the project, right from the start. Our experts offer consulting, on-site services, and technical support. We see ourselves as service providers, trainers and subject-matter experts.

1910
Founded in
Bamberg

1600+
Employees
worldwide



5
Production
sites

70+
Countries
worldwide

CONTENT

- 04** podis® – The power bus solution with tray cable power bus
- 06** podis® for every Application
- 08** Solutions for Airport logistics
- 10** Solutions for Automotive
- 12** Solutions for Intra logistics
- 14** Solutions for Mechanical engineering
- 16** Solutions for Wind energy systems
- 18** Solutions for Cranes, shafts, tunnels
- 20** Central | Decentralized installation
- 22** The connection principle
- 23** Quick installation in cable duct
- 24** podis® CON – power bus components
- 44** podis® Motor starter
- 54** podis® MOT – The Field distributors on the power bus
- 58** podis® LED – The maintenance-free light
- 66** Accessories
- 74** RST® – The pluggable round cable
- 90** podis® PLAN – the efficient project planning tool
- 91** Information and contacts

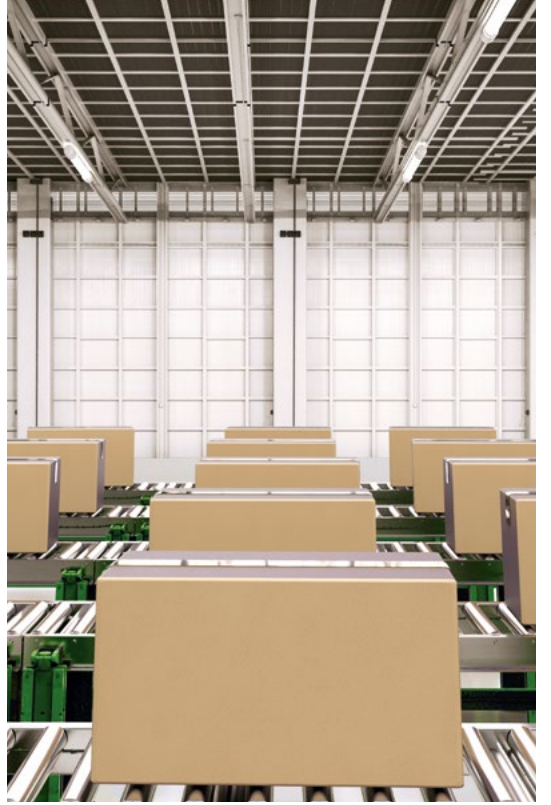



PODIS® – THE POWER BUS SOLUTION WITH TRAY CABLE POWER BUS.

podis® EFC – function modules can be mounted separately or directly on the power outputs. Direct, reversing or soft starter for three-phase asynchronous motors, field distributor for connection to SEW MOVIMOT drives, up to power-saving and long-lasting LEDs offer a wide application field in remote automation. Customer-specific functions can be easily integrated into the available modular housing concept.

The podis® power bus is the innovative solution in decentralized power distribution. The system includes feeder and distributor modules, service switches, fixed and plug-in power branches, pre-assembled cable sets and a wide range of accessories. The classic installation process is **reduced by up to 70 %** thanks to the **plug & play concept**.

SYSTEM SOLUTIONS FOR:

- + AIRPORT LOGISTICS
- + AUTOMOTIVE
- + INTRA LOGISTICS
- + MECHANICAL ENGINEERING
- + WIND ENERGY SYSTEMS
- + CRANES, SHAFTS, TUNNELS



ECONOMIC PLANNING

podis®-power bus solutions reduce the installation times, cut project costs and increase the flexibility of system expansions or later planning changes.



MODULAR INSTALLATION SYSTEM

podis® offers a wide range of system components that enable space-saving, extremely clear cable management.



QUICKER ASSEMBLY

With the piercing contacts, connection modules can be quickly and easily contacted with the power bus. No stripping and stripping of insulation required.

PODIS® FOR EVERY APPLICATION

podis®CON is a pluggable, modular power bus system for remote power supply. Because of the simple, non-interrupted maintenance and service possibilities, podis®CON guarantees the highest system availability. With it, many functions such as power distribution, illumination, or active components can be directly mounted to the power bus without requiring additional fastenings. With the podis®CON plug, as many additional devices as needed can be connected and flexibly positioned.

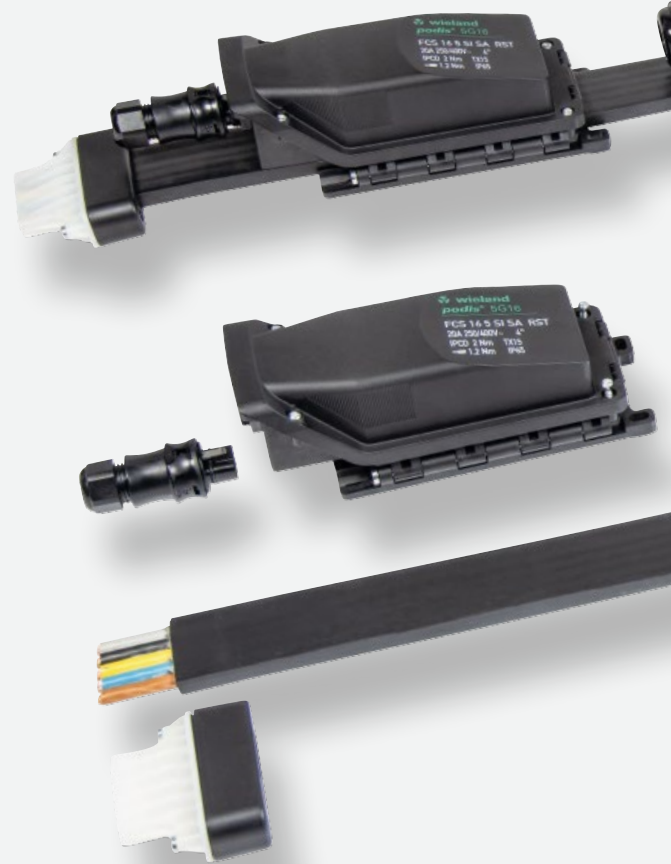

AIRPORT LOGISTICS

- Baggage conveyor technology
- Cargo conveyor technology



AUTOMOTIVE

- Skid conveyor technology
- "Power & Free" systems
- Floor conveyor technology
- Pulling chain conveyors
- Pallet conveyor technology

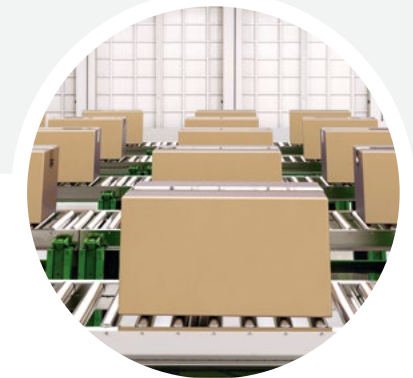

INTRA LOGISTICS

- Roller conveyors
- Belt conveyors
- Chain conveyors
- Pallet transportation
- Package conveyors



MECHANICAL ENGINEERING

- Packaging machines
- Robots
- Assembly and production lines
- Food production



WIND ENERGY SYSTEMS

- Tower Installation
- Nacelle
- Hub
- Service elevator

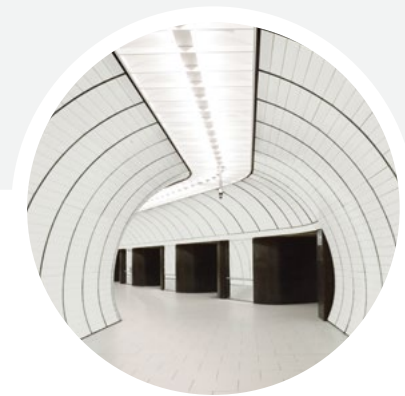

CRANES, SHAFTS, TUNNELS

- Gantry cranes
- Special cranes
- Ascents/descents
- Service tunnel
- Work areas



SOLUTIONS FOR **AIRPORT LOGISTICS**

- + Energy distribution without control cabinet
- + Flexible and modular
- + Time and cost savings

**APPLICATION AREAS**

- Baggage conveyors
- Cargo conveyors

**SOLUTIONS**

- Power distribution
- Decentralized motor starter
- Sensor connection

**BENEFITS**

- Easy project planning
- Fast, faultless installation
- Extends flexibility
- Degree of protection IP65

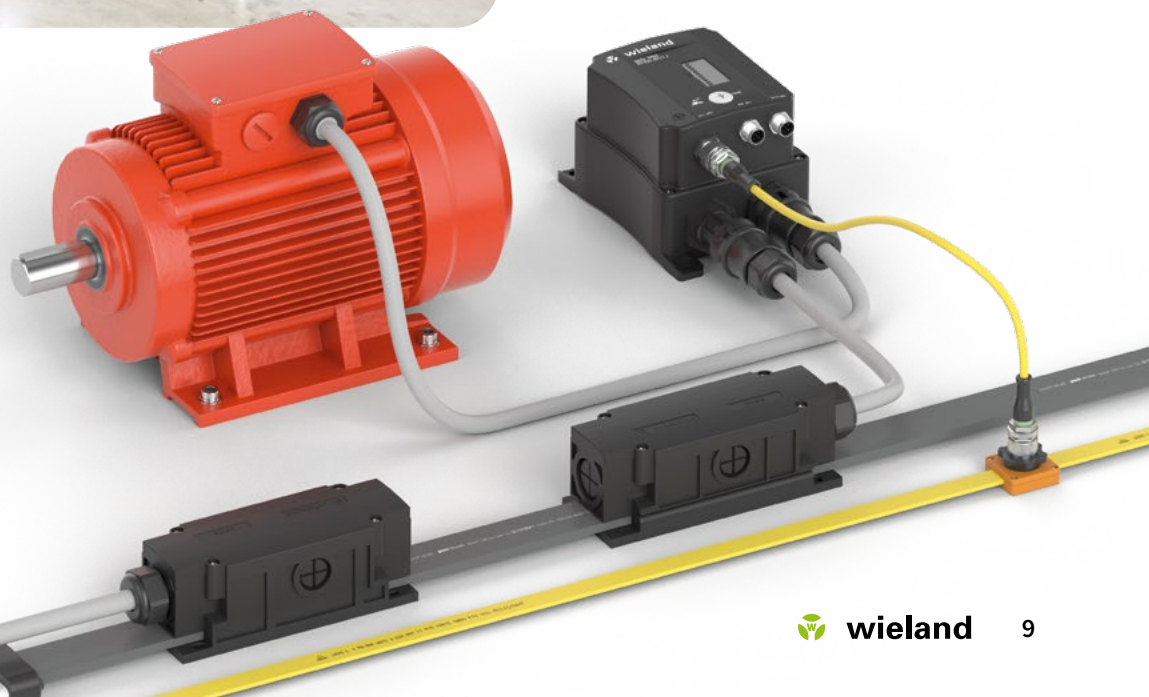



SOLUTIONS FOR **AUTOMOTIVE**

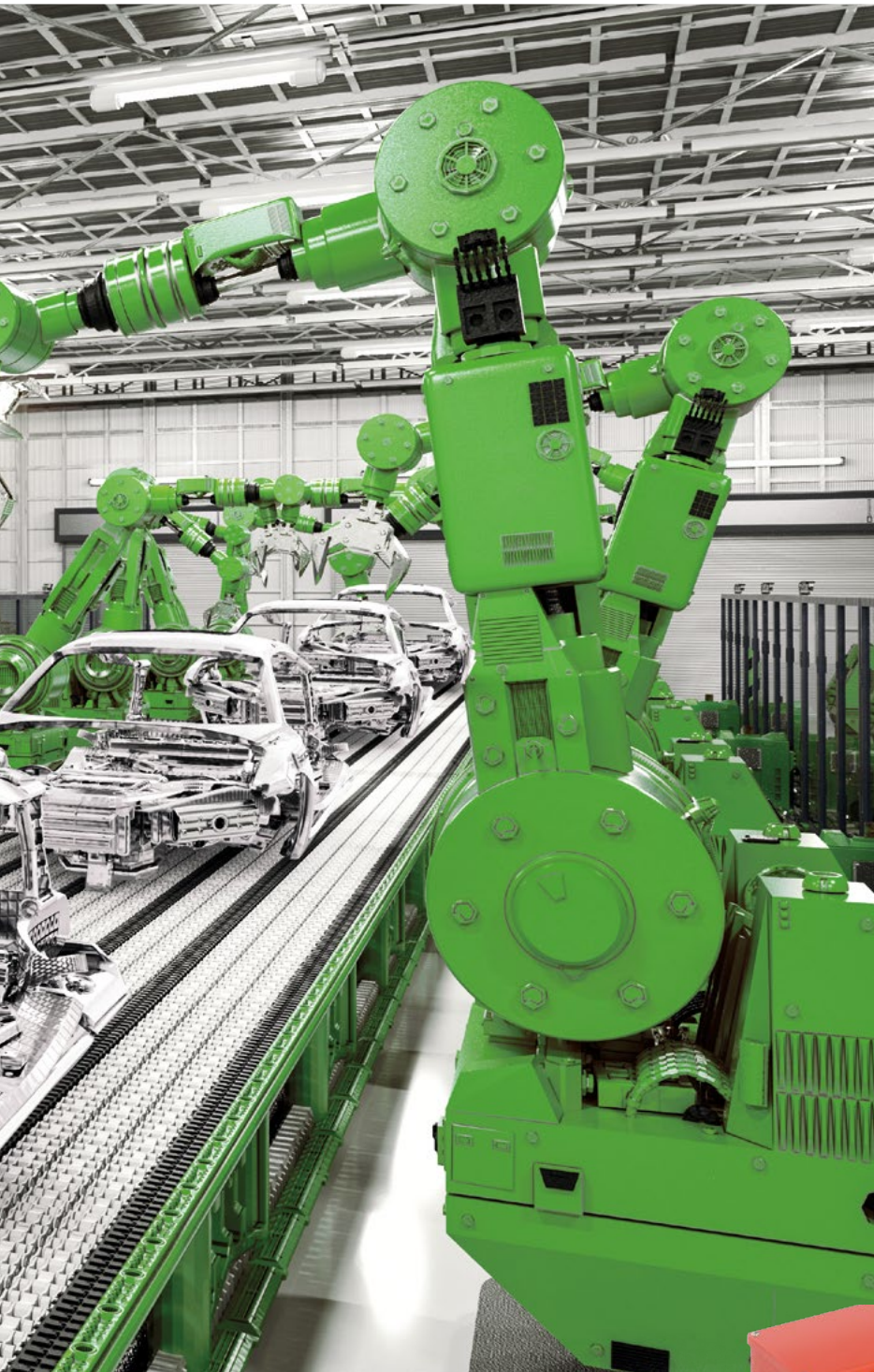

- + Short installation times
- + Optimum maintenance and repair
- + High plant availability

**APPLICATION AREAS**

- Skid conveyors
- Floor conveyors
- Roller conveyors
- Carrying chain conveyors
- “Power and Free” systems

**SOLUTIONS**

- Power distribution
- Field devices for SEW MOVIMOT
- I/O modules for sensor connection

**BENEFITS**

- Cost-optimized system
- Fast, faultless installation
- Rebuild flexibility in the modular system
- High machine availability

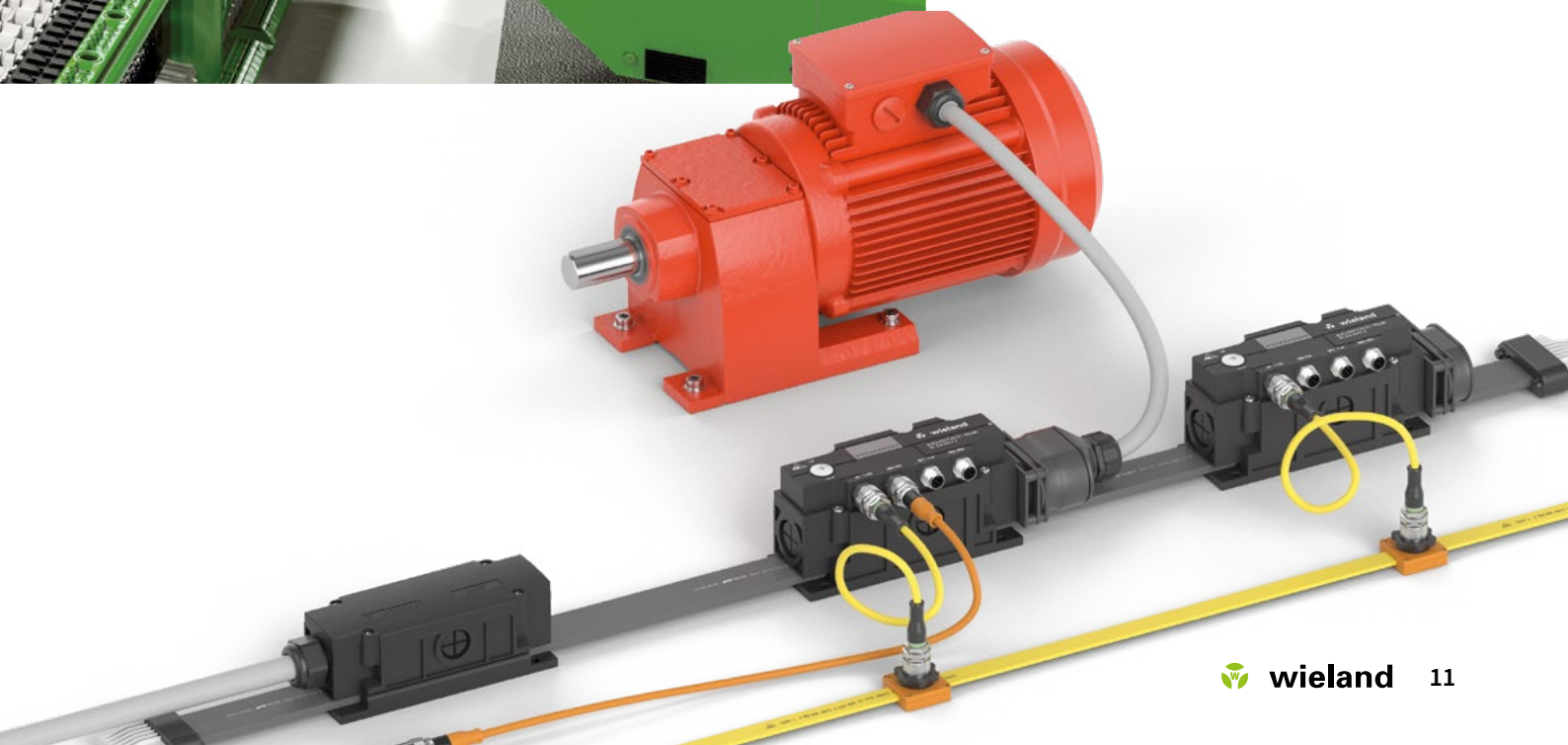



SOLUTIONS FOR **INTRA LOGISTICS**

- + Easy to engineer
- + Maintenance-friendly plug-in technology
- + Easy expansion

**APPLICATION AREAS**

- Roller conveyors
- Pallet conveyors
- Carrying chain conveyors
- Belt conveyors
- Container transportation
- Package conveyance

**SOLUTIONS**

- Power distribution
- Sensor connection
- Direct/Reversible/Soft starter
- Fieldbus control for SEW MOVIMOT
- 24 V power distribution

**BENEFITS**

- Fast, easy, faultless commissioning
- Compact motor starter
- Easy to modify or extend
- Durable system with high protection class

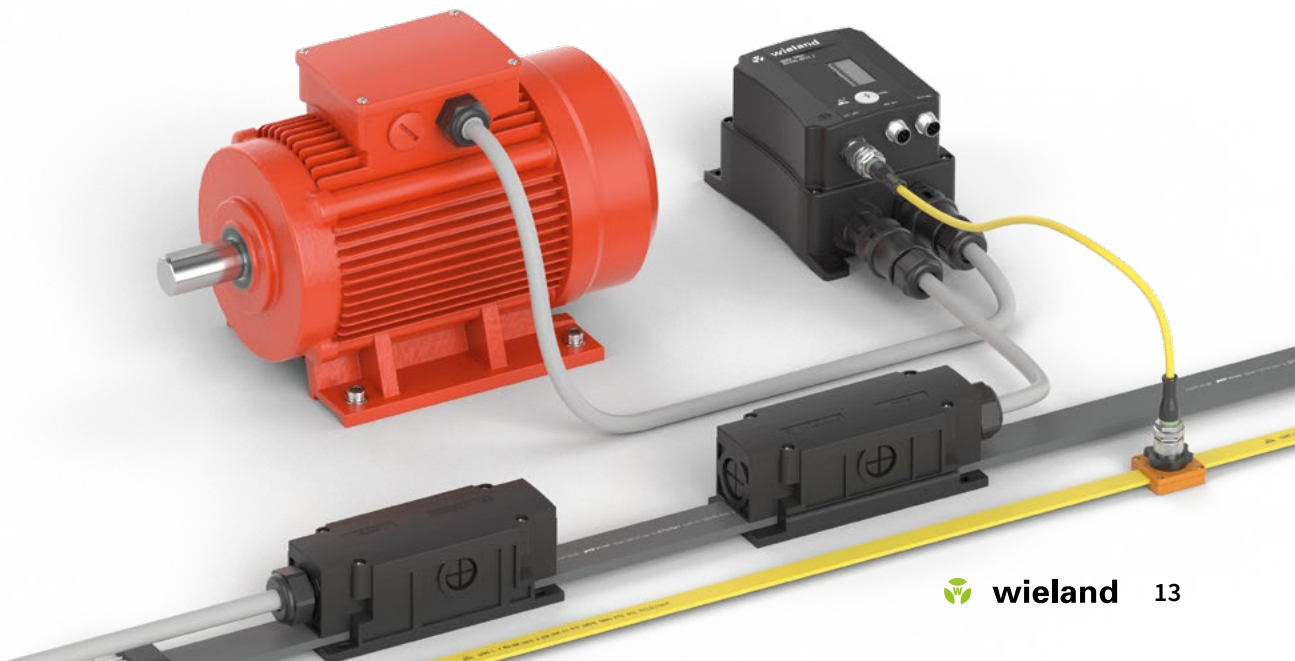



SOLUTIONS FOR **MACHINE CONSTRUCTION** AND **SYSTEM ENGINEERING**

- + Quick commissioning
- + Flexible retrofitting
- + Optimum maintenance and repair

**APPLICATION AREAS**

- Packaging machines
- Robots
- Assembly and production lines
- Food production

**SOLUTIONS**

- Power distribution
- Remote motor starter
- Fieldbus control
- Illumination module
- Maintenance sockets

**BENEFITS**

- Reduced complexity
- 400 V and 24 V on one strand
- Flexible, modular system
- High machine and system engineering availability
- Fast, simple, faultless installation
- High protection class IP65

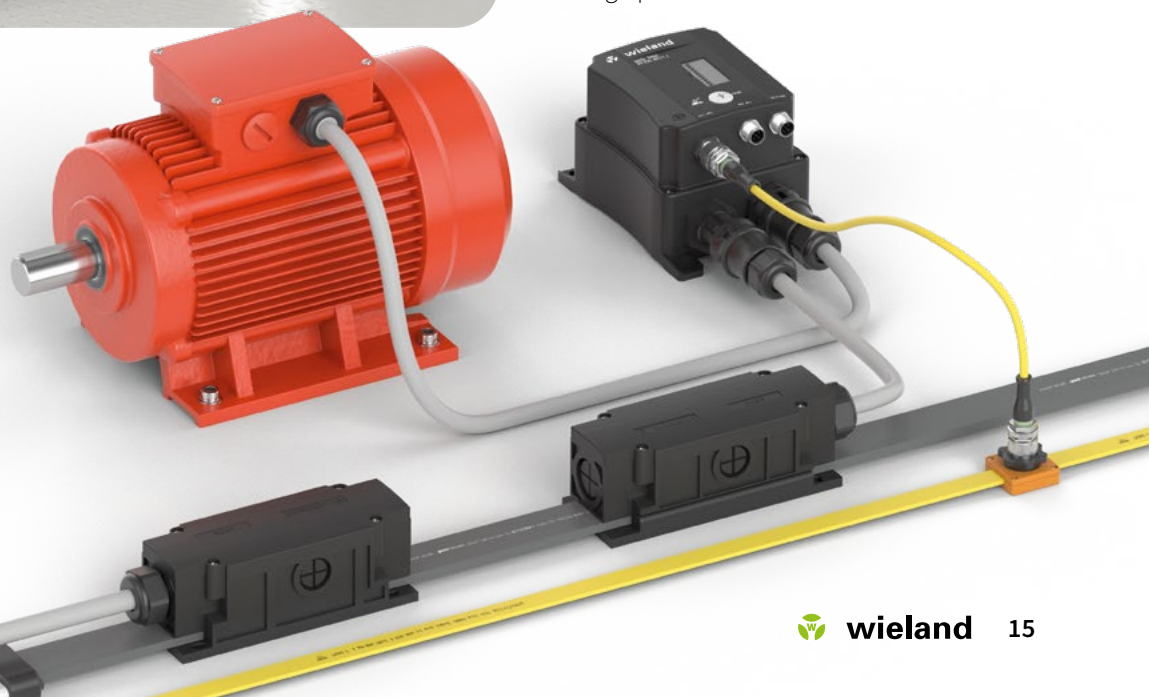



SOLUTIONS FOR **WINDPOWER**

- + Transparent cable routing
- + International Certificates / Approvals
- + Flexible and quick installation

**APPLICATION AREAS**

- Tower installation
- Nacelle
- Hub
- Service elevator

**SOLUTIONS**

- Tower electrification
- Lighting
- Fieldbus control
- Emergency lighting with UPS
- Maintenance sockets

**BENEFITS**

- Reduced complexity
- 400 V and 24 V on one strand
- Permanently safe operation
- Fast, simple, faultless installation
- High protection class IP65





SOLUTIONS FOR **CRANES, SHAFTS, TUNNELS**

- + Simple adjustment of the installation
- + On-site diagnosis
- + Maintenance-friendly plug-in technology

**APPLICATION AREAS**

- Gantry cranes
- Special cranes
- Ascents/descents
- Service tunnels
- Work areas

**SOLUTIONS**

- Power distribution
- Lighting modules
- Maintenance sockets

**BENEFITS**

- Fast installation of large line sections
- Installation easily expandable
- High operational reliability
- High protection class IP65

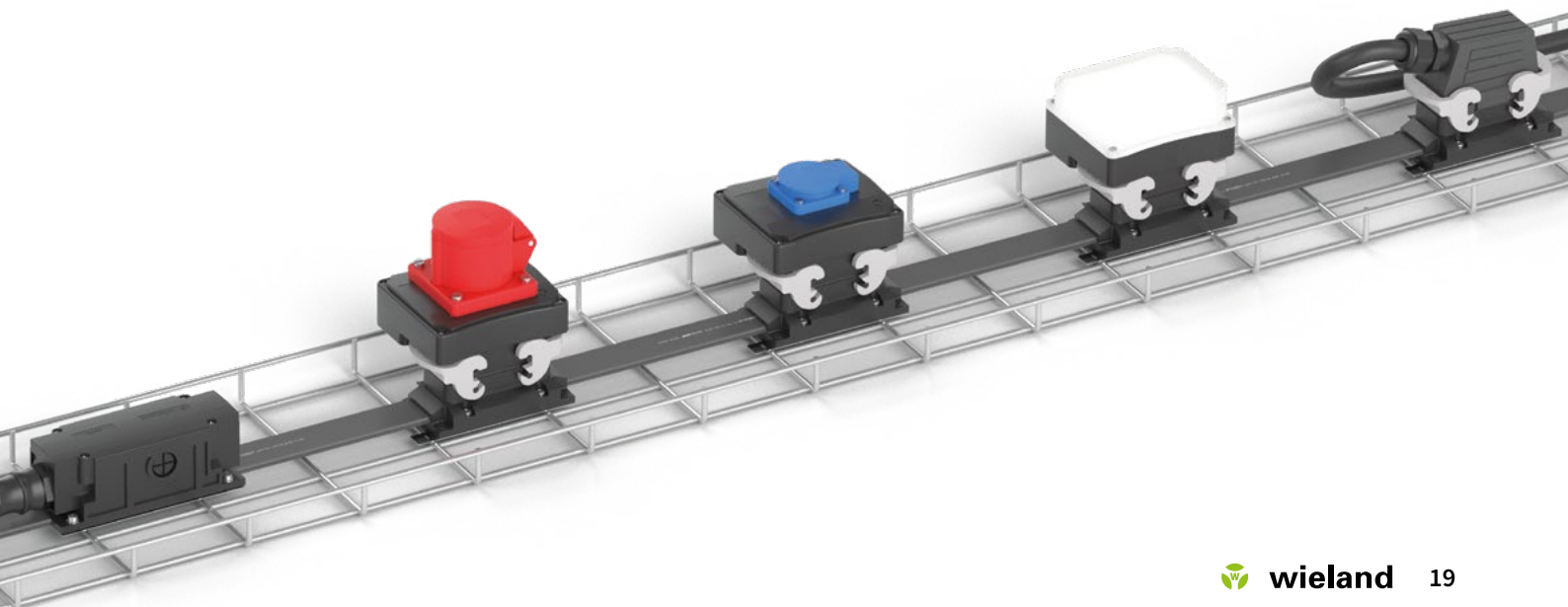

CENTRAL INSTALLATION – PREVIOUSLY CURRENT PRACTICE.

Long cabling distances, time-consuming installation, difficult upgrading and expansion are all characteristic of central installation.

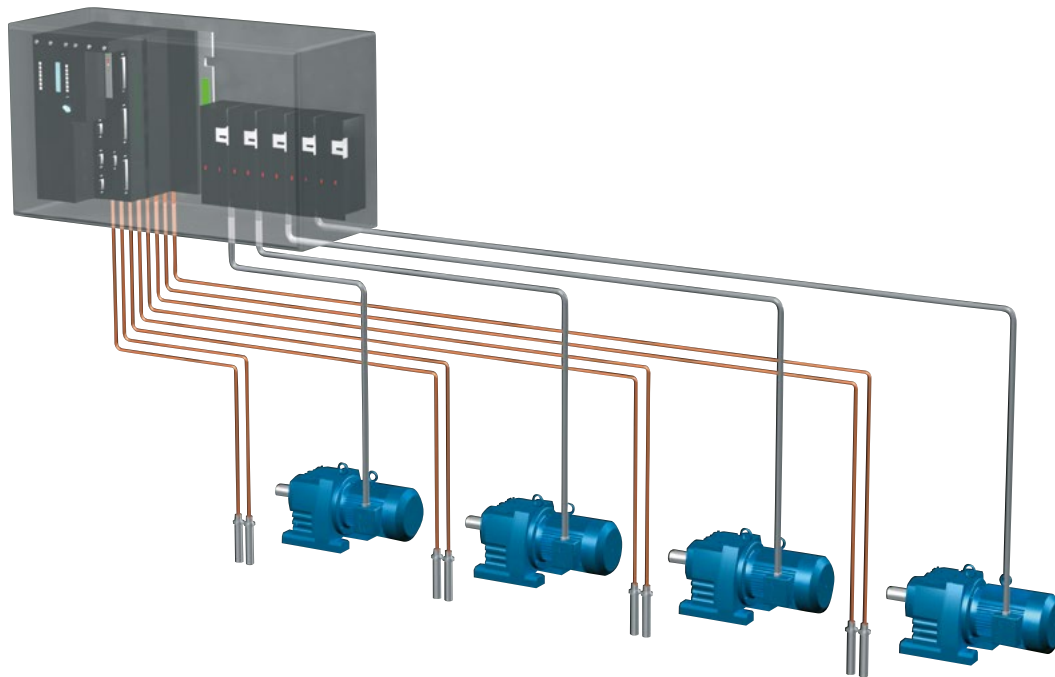

Central installation has been state of the art for many decades. It has served its purpose well in industrial automation. Its features include control cabinet fields with controllers, power distribution, motor circuit breakers and motor starters or frequency inverters. Cables connect the control cabinets and the individual drives as well as the sensors in the system or the machine.

In extensive systems this creates full cable trays and requires time-consuming installation. When system parts have to be changed or expanded this creates the need for more control cabinet volume. Cables must be installed retroactively throughout the entire system.



FEATURES OF CENTRAL:

- Time-consuming planning and configuration
- Large control cabinets
- Long cabling distances
- Complicated cable trays
- Difficult commissioning
- Costly expansions

DECENTRALIZED INSTALLATION – THE SMART SOLUTION.

Planning and configuration require less work. More space in the control cabinet.
Simple installation and expansion.

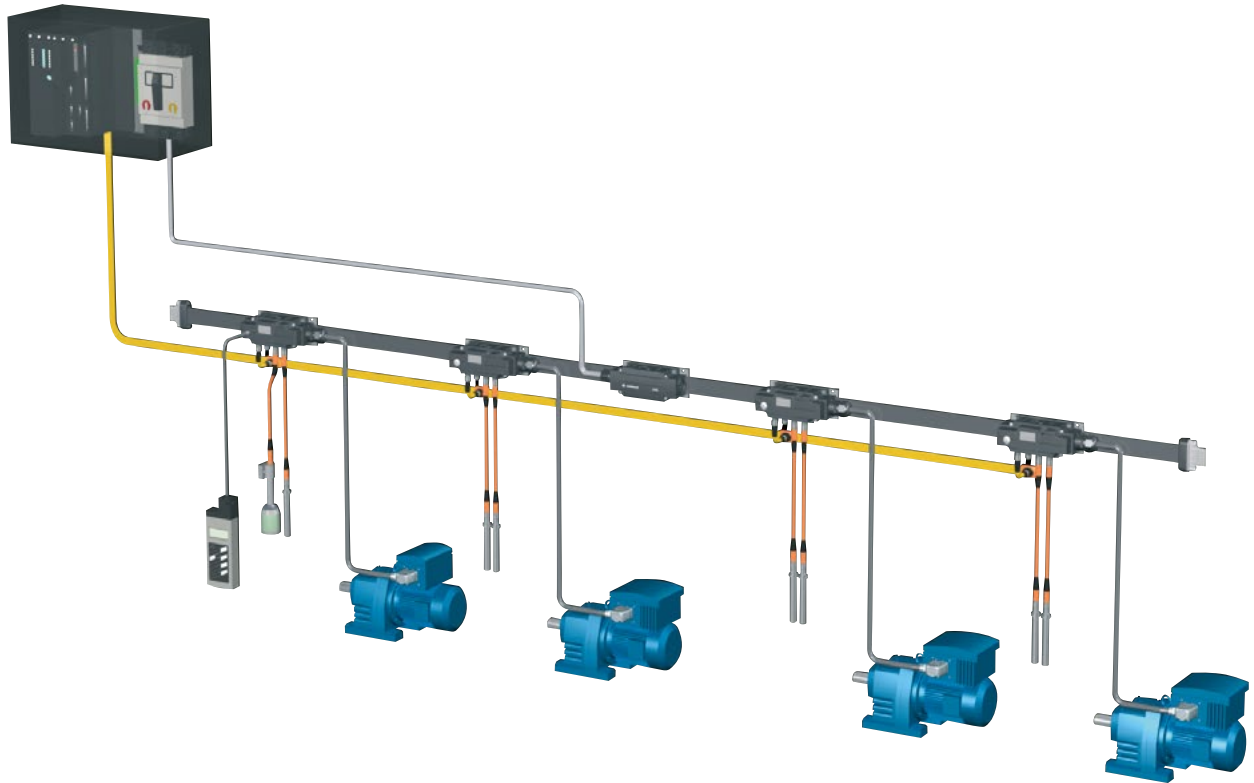

With the appropriate podis® installation systems Wieland power bus concepts are suitable for setting up distributed solutions for drive control on technical conveyor systems.

Possible applications range from pure power-distribution via fieldbus interface to motor starters for switching three-phase asynchronous motors. The connection to a fieldbus is integrated in the field distributor or motor starter and it is possible to connect sensors in addition to the drives.

The compact design and high protection rating (IP65) allow optimal integration even under cramped system conditions. That reduces planning and configuration time and saves space in the control cabinet



BENEFITS OF DECENTRALIZED:

- Simple configuration
- Short installation times
- Fast commissioning
- Flexible retrofitting
- Easy expansion
- Much less system downtime
- On-site diagnosis
- Maintenance-friendly, plug connection technology
- Optimal maintenance and repair

COST REDUCTION

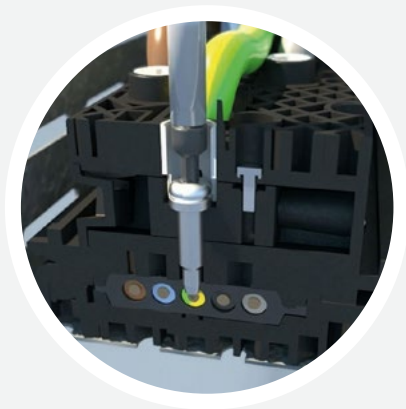

NO CABLE CUTTING NECESSARY

There is no need for any laborious cutting, baring, stripping, or clamping of the cables.

INSTALLATION AT ANY POINT AND AT ANY TIME

Flexible installation allows the connection modules to be terminated in any position. The modules can also be moved anywhere and at any time. Not just during installation and commissioning but also during the lifetime of the installation. Useful if the system needs modifying or expanding.



REDUCE COSTS WITH DECENTRALIZED INSTALLATION

When compared to a traditional centralized installation, decentralized solutions offer savings in wiring, cable trays, fixtures and remove the need for rigid steel conduit. It also reduces the number and size of distribution panels.

PODIS® – QUICK INSTALLATION IN CABLE DUCT.

podis® power bus solutions are optimally suited for laying and installing directly in cable ducts or in cable layouts. Because of the compact and narrow design (60 mm) and cables aligned longitudinally, the installation in the cable duct requires very little space.



Open the housing



Insert the round cable



Fastening the wires

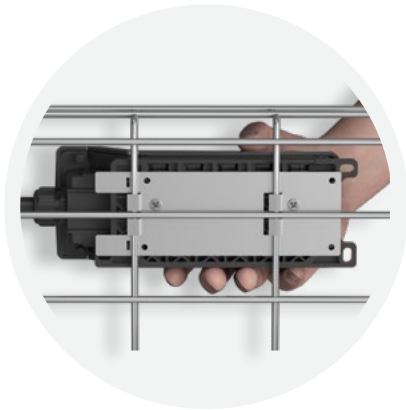

Mounting the module.
Here by using a mounting plate.

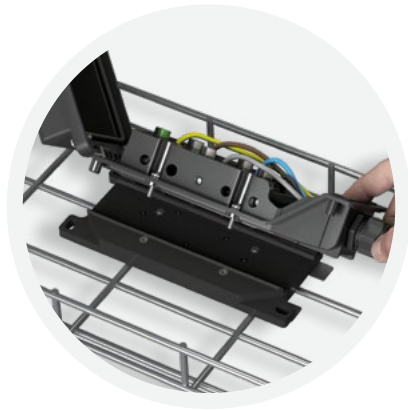

Open the housing base



Insert the tray cable and close
the housing base



Copper displacement connection
of the cable



Closing of the housing. Finished!



Faster installation with pre-wired,
pluggable RST® connector

PODIS® CON

Power bus components

The podis® power bus is the innovative solution in decentralized power distribution. The system includes solid and plug-in power taps and active field components.

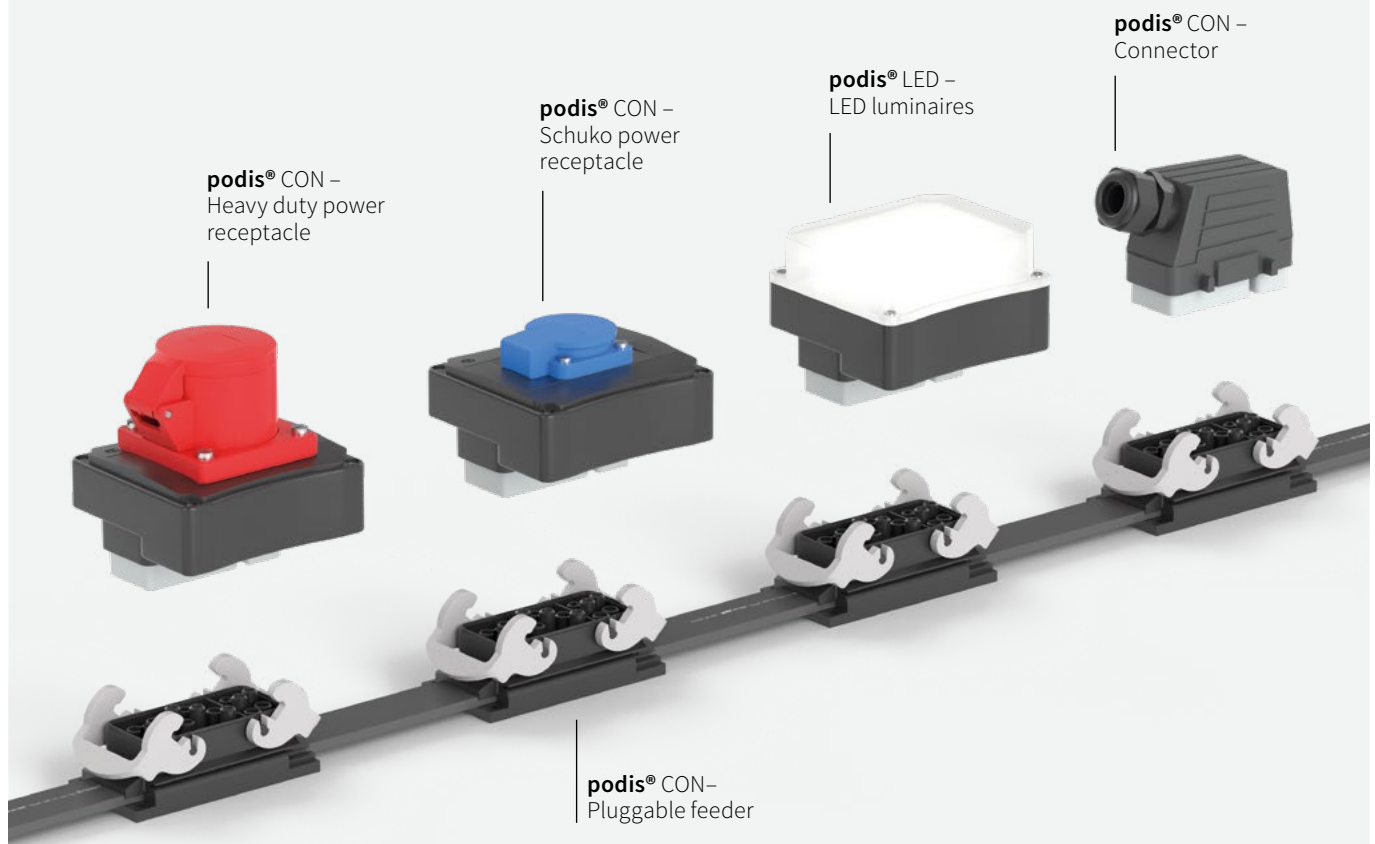

FEATURES

- + Stripping and dismantling are not required
- + Expandable at any time at any point
- + Permanently high contact quality with piercing technology
- + 5-core tray cable system
- + Connection cross section: up to 16 mm²
- + Current rating: 41 A

PODIS® CON TRAY CABLES 5G16

Tray cable



Tray cable podis® CON XPE 5G16; nominal ratings acc. VDE 63 A; 690 V; 6kV/3; nominal ratings acc. UL 61 A, 600 V; halogen-free, resistant to oil and acid, resistant to ozone and UV; fixed installation; color black.

Description	Type	Part No.	PU
Tray cable	XPE 5G16	00.729.0307.1	1

TECHNICAL DATA	
Nominal voltage U (V)	750
Nominal cross section of conductor (mm ²)	16
Color of outer sheath	Black
Material of outer sheath	Copolymer (XPE)
Number of cores	5
Core identification	Colored
Core insulation	XHH
Cable width approx. (mm)	48
Cable height approx. (mm)	12
Bending radius, static (mm)	60
Flame retardant	Acc. EN 50265-2-1
Halogen-free according to EN 50267-2-1	Yes
Certificates / Approvals	UL Listed TC-ER (E492844), cURAWM (E172203) and UL Listed (E480715)

Tray cable



Tray cable podis® CON Li2HH 5G16; 0.6/1kV; CPR class B2ca-s1a-d1-a1; ampacity acc. VDE 0298-4 tables 5 and 6; halogen-free, flame retardant; fixed installation; color black.

Description	Type	Part No.	PU
Tray cable	Li2HH 5G16	00.770.0307.1	1

TECHNICAL DATA	
Nominal voltage U (V)	600/1.000
Nominal cross section of conductor (mm ²)	16
Color of outer sheath	Black
Material of outer sheath	Polyolefincompound HM4
Number of cores	5
Core identification	Colored
Core insulation	Polyolefincompound HM2
Cable width approx. (mm)	48
Cable height approx. (mm)	11.5
Bending radius, static (mm)	70
Fire behavior according to EN 50575:2014	B2ca-s1a-d1-a1
Halogen-free according to EN 50267-2-1	Yes

Tray cable



Tray cable podis® CON FL-Li2HH 5G16; 0.6/1kV; CPR class B2ca-s1a-d1-a1; ampacity acc. VDE 0298-4 tables 5 and 6; halogen-free, flame retardant; fixed installation; color black.

Description	Type	Part No.	PU
Tray cable	FL-Li2HH 5G16	00.771.0307.1	1

TECHNICAL DATA	
Nominal voltage U (V)	600/1.000
Nominal cross section of conductor (mm ²)	16
Color of outer sheath	Black
Material of outer sheath	Polyolefincompound
Number of cores	5
Core identification	Colored
Core insulation	XLPE
Cable width approx. (mm)	48
Cable height approx. (mm)	11.5
Bending radius, static (mm)	60
Fire behavior according to EN 50575:2014	B2ca-s1a-d1-a1
Halogen-free according to EN 50267-2-1	Yes

PODIS® CON CONNECTION MODULES FOR 5G16

Connection module



Connection module podis® CON 5G16 for fixed wiring with M25/M32 cable gland; 5-pole; nominal ratings acc. VDE 40A/63A; 690 V; 6kV/3; nominal ratings acc. UL 32 A; 600 V degree of protection IP65; piercing contacts; Torx 15; screw clamps max. 16 mm² (AWG 6) single/fine-stranded; max. cable diameter; housing black; mounting position any.

Description	Type	Part No.	Part No.	PU
Connection module	FCS 16 5 SI SA M32	75.456.0053.1		1
Connection module	FCS 16 5 SI SA M25		75.456.0153.1	1

TECHNICAL DATA				
Rated voltage (V)	690 / 600 for UL			
Rated current (A)	41			
Number of poles	5			
Connection type 1	Penetration connection			
Connection type 2	Screw connection			
Min. rated cross section, finely stranded (mm ²)	1.5	1.5		
Max. rated cross section, finely stranded (mm ²)	16	16		
Max. cable diameter (mm)	10-25	9-18		
Color	Black			
Degree of protection (not verified by UL)	IP65			
Length x Width x Height (mm)	218 x 84 x 80	218 x 84 x 80		
Certificates / Approvals	UL Listed (E480715) and cULus Listed (E247489)			

Connection module



Connection module podis® CON 5G16; 5-pole; nominal ratings acc. VDE 20A; 690 V; 6kV/3; nominal ratings acc. UL 20 A; 600 V degree of protection IP65; piercing contacts; Torx 15; screw clamps max. 16 mm² (AWG 6) single/fine-stranded; max. cable diameter; housing black; mounting position any.

Description	Type	Part No.	PU
Connection module	FCS 16 5 SI SA RST	75.452.0053.1	1

TECHNICAL DATA			
Rated voltage (V)	690 / 600 for UL		
Rated current (A)	20		
Number of poles	5		
Connection type 1	Penetration connection		
Connection type 2	Screw connection		
Min. rated cross section, finely stranded (mm ²)	1.5		
Max. rated cross section, finely stranded (mm ²)	6		
Color	Black		
Degree of protection	IP65		
Length x Width x Height (mm)	218 x 84 x 80		
Certificates / Approvals	UL Listed (E480715) and cULus Listed (E247489)		



You will find our RST® connector system as a system supplement to the podis® products from page 78 onwards.

PODIS® CON

FEED-IN MODULES FOR 5G16

Feed-in module

Feed-in module for tray cable podis®CON 5G16 connection by roundcable; M50-cable gland; 5-pole; nominal ratings acc. VDE 63A; 690 V; 6kV/3; nominal ratings acc. UL 61 A; 600 V; degree of protection IP65; screw clamps max. 35 mm² (AWG 2) single/fine-stranded; housing grey; mounting position any



Description	Type	Part No.	Part No.	PU
Feed-in module	FCS 16 5 SA SA M50 G	75.450.0014.3		1
Feed-in module	FCS 16 5 SA SA M50 K		75.450.0214.3	1

TECHNICAL DATA				
Rated voltage (V)		690 / 600 for cULus	690 / 600 for cULus	
Rated current (A) / for USA / for Canada		100/65/75	100/65/75	
Number of poles		5	5	
Connection type		Screw terminal		
Min. rated cross section, finely stranded (mm²)		10	10	
Max. rated cross section, finely stranded (mm²)		35	35	
Max. cable diameter (mm)		30-38	25-31	
Color		Black		
Degree of protection		IP65		
Length x Width x Height (mm)		300 x 145 x 100	300 x 170 x 120	
Certificates / Approvals		UL Listed (E480715) and cULus Listed (169904)	UL Listed (E480715) and cULus Listed (169904)	

Feed-in module

Feed-in module for tray cable podis®CON 5G16 connection by roundcable; M50-/M63-cable gland; 5-pole; nominal ratings acc. VDE 63A; 690 V; 6kV/3; nominal ratings acc. UL 61 A; 600 V; degree of protection IP65; screw clamps max. 35 mm² (AWG 2) single/fine-stranded; max. cable diameter 25-31/ 29-35 mm; housing grey; mounting position any



Description	Type	Part No.	Part No.	PU
Feed-in module	FCS 16 5 SA SA M63 G	75.450.0114.3		1
Feed-in module	FCS 16 5 SA SA M63 K		75.450.0314.3	1

TECHNICAL DATA				
Rated voltage (V)		690 / 600 for UL	690 / 600 for UL	
Rated current (A)		100	100	
Number of poles		5	5	
Connection type 1		Screw connection		
Min. rated cross section, finely stranded (mm²)		10	10	
Max. rated cross section, finely stranded (mm²)		70	70	
Max. cable diameter (mm)		34-44	29-35	
Color		light gray		
Degree of protection		IP65		
Length x Width x Height (mm)		300 x 145 x 100	300 x 170 x 120	
Certificates / Approvals		UL Listed (E480715) and cULus Listed (169904)	UL Listed (E480715) and cULus Listed (169904)	

ACCESSORIES



Description	Type	Part No.	PU
Cable gland	M25 x 1.5, (for cable 9-16 mm) black	Z5.507.1453.1	1
Cable gland	M25 x 1.5, (for cable 13-18 mm) black	Z5.507.1553.1	1
Lock nut	M25 x 1.5, black	05.505.0253.1	1
Cable gland	M32 x 1.5, (for cable 10-21 mm) black	Z5.507.1753.1	1
Cable gland	M32 x 1.5, (for cable 18-25 mm) black	Z5.507.1653.1	1
Lock nut	M32 x 1.5, black	05.505.0353.1	1
Multiple feed-through	3 x 8 mm for M25, Z5.507.1553.1	05.512.4883.0	1
Multiple feed-through	4 x 7 mm for M25, Z5.507.1553.1	05.512.5083.0	1
Multiple feed-through	2 x 8 mm for M32, Z5.507.1653.1	05.512.4383.0	1

Screw driver insert

Screw driver insert Torx TX 15x70.



Description	Type	Part No.	PU
Screwdriver blade	Bit Torx 15 x 70	06.502.6410.0	1

Cable patch

Insulation tape for tray cables podis® 5G6, podis® 5G16 and flat cable gesis® NRG.

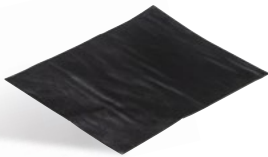

Description	Type	Part No.	PU
Cable patch	podis®/gesis® 140 x 152 mm	Z6.563.7800.0	1

Cable end piece

Cable end piece for podis® 5G16 tray cable; black / transparent.



Description	Part No.	PU
Cable end piece	Z6.563.6553.0	1

Feed-through tray cable

Feed-through tray cable for podis® 5G16 tray cable.



Description	Part No.	PU
Feed-through tray cable	Z7.432.8053.0	1

PODIS® CON

TRAY CABLES 5G6 / CONNECTION MODULES FOR 5G6

Tray cable

Tray cable podis® CON XPE 5G6; nominal ratings acc. VDE 45 A; 690 V; 6kV/3; nominal ratings acc. UL 40 A, 600 V; halogen-free, resistant to oil and acid, resistant to ozone and UV; fixed installation; color black



Description	Type	Part No.	PU
Tray cable	XPE 5G6	00.729.0305.1	1

TECHNICAL DATA	
Nominal voltage U (V) according to VDE	750
Nominal voltage U (V) according to UL	600
Nominal cross section of conductor (mm ²)	6
Color of outer sheath	Black
Material of outer sheath	Copolymer (XPE)
Number of cores	5
Core identification	Colored
Cable width approx. (mm)	43
Cable height approx. (mm)	7.5
Bending radius, static (mm)	30 mm
Flame retardant according to	EN 50265-2-1
Halogen-free according to	EN 50267-2-2
Certificates / Approvals	UL Listed TC-ER (E492844), cUR AWM (E172203) and UL Listed (E480715)

Connection module

Connection module podis® CON 5G6 for fixed wiring with M32 cable gland; 5-pole; nominal ratings acc. VDE 41A; 690 V; 6kV/3; nominal ratings acc. UL 40 A; 600 V degree of protection IP65; piercing contacts; Torx 15; screw clamps max. 16 mm² (AWG 6) single/fine-stranded; max. cable diameter 10-25 mm.



Description	Type	Part No.	PU
Connection module	FCS 6 5 SI SA M32	75.250.0053.1	1

TECHNICAL DATA	
Rated voltage (V) VDE	690
Rated current (A) VDE	41
Rated voltage (V) UL	600
Rated current (A) UL	32
Number of poles	5
Connection type 1	Insulation-penetrating termination
Connection type 2	Screw terminal
Rated cross section, finely stranded (mm ²)	1.5 ... 16
Max. connection cable diameter	25 mm
Cable feed	M32 cable screw gland
Degree of protection	IP65
Color	Black
Dimensions L x W x H (mm)	218 x 84 x 74
Certificates / Approvals	UL Listed (E480715) and cULus Listed (E247489)

Connection module

Connection module podis® CON 5G6 for pluggable connection with RST20i5; 5-pole; nominal ratings acc. VDE 20A; 690 V; 6kV/3; nominal ratings acc. UL 20 A; 600 V degree of protection IP65; piercing contacts; Torx 15; single/fine-stranded; housing black; mounting position any.



Description	Type	Part No.	PU
Connection module	FCS 6 5 SI SA RST 20i5	75.252.0053.1	1
Connection module	FCS 6 5 SI SA RST 20i5 LH	75.252.0153.1	1

TECHNICAL DATA	
Rated voltage (V) VDE	690
Rated current (A) VDE	20
Rated voltage (V) UL	600
Rated current (A) UL	20
Number of poles	5
Connection type 1	Insulation-penetrating termination
Connection type 2	Screw terminal
Rated cross section, finely stranded (mm ²)	1.5 ... 16
Connection	RST20i5 black female connector
Degree of protection	IP65
Color	Black
Dimensions L x W x H (mm) FCS 6 5 SI SA RST 20i5	218x84x74
Dimensions L x W x H (mm) FCS 6 5 SI SA RST 20i5 LH	218x84x59
Certificates / Approvals	UL Listed (E480715) and cULus Listed (E247489)

PODIS® CON

CONNECTION MODULES FOR 5G6

Connection module

Connection module podis® CON 5G6 for fixed wiring with M25 cable gland; 5-pole; nominal ratings acc. VDE 40A; 690 V; 6kV/3; nominal ratings acc. UL 32 A; 600 V degree of protection IP65; piercing contacts; Torx 15; screw clamps max. 16 mm² (AWG 6) single/fine-stranded; max. cable diameter 9-18 mm; housing black; mounting position any.



Description	Type	Part No.	PU
Connection module	FCS 6 5 SI SA M25	75.256.0053.1	1
Connection module	FCS 6 5 SI SA M25 LH	75.256.0153.1	1

TECHNICAL DATA	
Rated voltage (V) VDE	690
Rated current (A) VDE	41
Rated voltage (V) UL	600
Rated current (A) UL	32
Number of poles	5
Connection type 1	Insulation-penetrating termination
Connection type 2	Screw terminal
Rated cross section, finely stranded (mm ²)	1.5 ... 16
Connection cable	RST20i5 black female connector
Cable feed	M25 cable screw gland
	Note: for FCS 6 5 SI SA M25 LH use only Z5.507.1453.1.
Degree of protection	IP65
Color	Black
Dimensions L x W x H (mm) FCS 6 5 SI SA RST 20i5	218x84x74
Dimensions L x W x H (mm) FCS 6 5 SI SA RST 20i5 LH	218x84x59
Certificates / Approvals	UL Listed (E480715) and cULus Listed (E247489)



You will find our RST® connector system as a system supplement to the podis® products from page 78 onwards.

ACCESSORIES



Description	Type	Part No.	PU
Cable gland	M25 x 1.5, (for cabel 9-16 mm) black	Z5.507.1453.1	1
Cable gland	M25 x 1.5, (for cabel 13-18 mm) black	Z5.507.1553.1	1
Lock nut	M25 x 1.5, black	05.505.0253.1	1
Cable gland	M32 x 1.5, (for cabel 10-21 mm) black	Z5.507.1753.1	1
Cable gland	M32 x 1.5, (for cabel 18-25 mm) black	Z5.507.1653.1	1
Lock nut	M32 x 1.5, black	05.505.0353.1	1
Multiple feed-through	3 x 8 mm for M25, Z5.507.1553.1	05.512.4883.0	1
Multiple feed-through	4 x 7 mm for M25, Z5.507.1553.1	05.512.5083.0	1
Multiple feed-through	2 x 8 mm for M32, Z5.507.1653.1	05.512.4383.0	1

Screw driver insert

Screw driver insert Torx TX 15x70.



Description	Type	Part No.	PU
Screwdriver blade	Bit Torx 15 x 70	06.502.6410.0	1

Cable patch

Insulation tape for tray cables podis® 5G6, podis® 5G16 and flat cable gesis® NRG.



Description	Type	Part No.	PU
Cable patch	podis®/gesis® 140 x 152 mm	Z6.563.7800.0	1

Cable end piece

Cable end piece for podis® 5G6 tray cable; black / transparent.



Description	Part No.	PU
Cable end piece	Z6.563.6053.0	1

TRAY CABLE PODIS® CON 7G4

Current load capacity

In accordance with the applicable regulations, the installation, commissioning and maintenance of all podis® CON components must be carried out by qualified expert personnel.

FEATURES:

- Must be fused with a mains disconnection switch in compliance with DIN VDE 0100 Part 460 and 537.
- Must only be operated on mains with grounded supply (TN-S systems).
- A non-grounded installation of podis® systems is not permitted.
- According to DIN VDE 0100-520, cables and cable systems including accessories must only be installed at ambient temperatures that are within the applicable cable standards or the limit values stated by the manufacturer.



You will find the limit values for the tray cable for a given fuse in dependence on the type of installation and the number of loaded conductors in Table 1 presented below.

The limit values for the connection components in dependence on the temperature and the loaded strands are found in Table 2.

Table 1
Current load capacity of the podis® CON tray cable PVC 7G4 mm² (00.709.0504.1)

Loaded strand	In the open d > 10 mm			Loose on wall or floor			Cable duct		
	3	5	6	3	5	6	3	5	6
Ta [°C]	Max. cross current			Max. cross current			Max. cross current		
20	40	35	35	40	32	32	35	30	25
25	40	35	35	35	32	30	35	30	25
30	40	35	32	35	30	25	32	25	25
35	35	32	30	32	25	25	30	25	25
40	35	30	25	30	25	25	25	20	20
45	32	25	25	25	20	20	25	20	20
50	25	25	20	25	20	20	20	20	16

Table 2
Limit values of the podis® CON connection components on the tray cable EVA 7G4 mm² (00.709.0504.1), valid for: Connection module, fixed 7-pole tension spring connection (75.018.0051.2) and tray cable outlet pluggable; 7-pole (75.015.5153.1)

Ambient temperature Ta [°C]	Contacting point						
	1	2	3	4	PE	5	6
20	25	25	25	0	0	25	25
25	25	25	25	0	0	25	25
30	25	25	25	0	0	25	25
35	25	25	25	0	0	25	25
40	23	23	23	0	0	23	23
50	19	19	19	0	0	19	19
70	12	12	12	0	0	12	12

PODIS® CON TRAY CABLES 7G4

Tray cable



Tray cable podis® CON EVA 7G 4, fine-stranded, number-coded wires; external dimensions approx. 35 x 6 mm; weight approx. 440 g / m; 450/750V acc. to VDE; halogen and silicone-free, oil and acid-proof; low calorific potential; sheath black.

Description	Type	Part No.	PU
Tray cable	EVA 7 G 4 black	00.709.0504.1	1

TECHNICAL DATA	
Nominal voltage U (V)	750
Nominal cross section of conductor (mm ²)	4
Color of outer sheath	Black
Material of outer sheath	Rubber (EVA)
Number of cores	7
Core identification	Figures
Core insulation	EVA
Cable width approx. (mm)	35
Cable height approx. (mm)	6
Bending radius, static (mm)	18
Flame retardant	according to EN 50265-2-1
Oil-resistant according to EN 60811-2-1	Yes
Halogen-free according to EN 50267-2-2	Yes

Tray cable

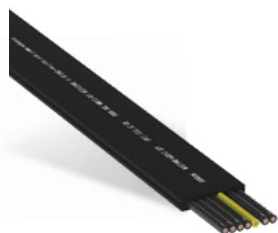

Tray cable podis® CON XLPE 7G4, fine-stranded, number-coded wires ; external dimensions approx. 35 x 6 mm, 600 V acc. to UL, UL 1277, halogen-free, low smoke emission, sheath black.

Description	Type	Part No.	PU
Tray cable	XLPE 7 G 4 black	00.729.0504.1	1

TECHNICAL DATA	
Nominal voltage U (V)	600
Nominal cross section of conductor (mm ²)	4
Color of outer sheath	Black
Material of outer sheath	XLPE
Number of cores	7
Core identification	Figures
Core insulation	XLPE
Cable width approx. (mm)	35
Cable height approx. (mm)	6
Bending radius, static (mm)	100
Oil-resistant according to EN 60811-2-1	Yes
Halogen-free according to EN 50267-2-2	Yes
Certificates / Approvals	UL Listed TC-ER (E301973) and UL Listed (E480715)

Tray cable



Tray cable podis® CON PVC 7G4, fine stranded, number-coded wires; external dimensions approx. 35 x 6 mm, 600 V acc. to UL, TC- ER UL 1277, cUR-AWM Class II Group A/B, FT4, 90 °C, sheath black.

Description	Type	Part No.	PU
Tray cable	PVC 7 G 4 Black	00.704.0504.1	1

TECHNICAL DATA	
Nominal voltage U (V)	600
Nominal cross section of conductor (mm ²)	4
Color of outer sheath	Black
Material of outer sheath	PVC
Number of cores	7
Core identification	Figures
Core insulation	PVC
Cable width approx. (mm)	35
Cable height approx. (mm)	6
Bending radius, static (mm)	72
Oil-resistant according to EN 60811-2-1	Yes
Halogen-free according to EN 50267-2-2	no

ACCESSORIES



Description	Type	Part No.	PU
Cable gland	M20 x 1.5, black	Z5.507.1353.1	1
Cable gland	M20 x 1.5, with AS-i-insert, black	Z5.505.0653.1	1
Lock nut	M20 x 1.5, black	05.505.0153.1	1
Cable gland	M25 x 1.5, (for cable 9-16 mm) black	Z5.507.1453.1	1
Cable gland	M25 x 1.5, (for cable 13-18 mm) black	Z5.507.1553.1	1
Lock nut	M25 x 1.5, black	05.505.0253.1	1

Screw driver insert



Screw driver insert Phillips Gr. 1; Shaft length 45 mm.

Description	Part No.	PU
Screwdriver blade DIN 3128	06.502.5200.0	10

Cable end piece



Cable end piece for podis®7G4 tray cable; protection class IP65; black/transparent.

Description	Part No.	PU
Cable end piece	Z5.562.7553.1	1

Feed-through tray cable



Feed-through tray cable for podis® tray cable 7 x 2.5 mm² and 7 x 4 mm²; protection class IP65; black.

Description	Part No.	PU
Feed-through tray cable	Z5.563.6553.1	1

FL-Sleeve



Sealing sleeve for podis® CON tray cable for sealing the contact points; protection class IP65; black.

Description	Type	Part No.	PU
FL-Sleeve		Z1.005.6553.1	1

PODIS® CON CONNECTION MODULES FOR 7G4

Connection module

7-pole, fixed



Connection module podis® CON FCS 4 7 SI FK; 7-pole, 20 A; 277/480 V 4kV/3 (VDE); degree of protection IP65; penetration contacts; 1 x 4/6 mm², fine-stranded/single-wired via spring-loaded terminals; 4 break points (2 x M20, 2 x M25); black.

Description	Type	Part No.	PU
Connection module	FCS 4 7 SI FK	75.018.0051.2	1

TECHNICAL DATA

Rated voltage (V)	500 / 600 for UL
Rated current (A)	20
Number of poles	7
Connection type 1	Penetration connection
Connection type 2	Cage clamp connection
Min. rated cross section, finely stranded (mm ²)	1.5
Max. rated cross section, finely stranded (mm ²)	4
Color	Black
Degree of protection	IP65
Length x Width x Height (mm)	160x60x60
Certificates / Approvals	UL Listed (E480715) and cURus (E247489)

Connection module

7-pole with
quick installation plate



Connection module podis® CON FCS 4 7 SI FK FM; with quick installation plate for mesh cable tray OBO-Bettermann; 7-pole, 20 A; 277/480 V 4 kV/3 (VDE); 600 V (UL, CSA); protection class IP65; insulation-penetrating contact; 1 x 4/6 mm², single-core/finely stranded via tension spring terminals; 4 rated break points (2 x M20, 2 x M25); black

Description	Type	Part No.	PU
Connection module	FCS 4 7 SI FK FM	99.801.4866.1	1

TECHNICAL DATA

Rated voltage (V)	500 / 600 for UL
Rated current (A)	20
Number of poles	7
Connection type 1	Penetration connection
Connection type 2	Cage clamp connection
Min. rated cross-section, fine-stranded (mm ²)	1.5 mm ²
Max. rated cross-section, fine-stranded (mm ²)	4 mm ²
Mounting method	Fast mesh cable tray installation
Color	Black
Degree of protection	IP65
Min. ambient temperature	-30 °C
Max. ambient temperature	55
Storage temperature / transport min.	-40 °C
L x W x H (mm)	180x60x67
Certificates / Approvals	UL Listed (E480715) and cURus (E247489)

PODIS® CON CONNECTION MODULES FOR 7G4

Distribution module 7-pole



Distribution module podis® CON FCS 4 7 SA SA; 7-pole, 32 A; 7 x 32 A (VDE) or 7 x 30 A (UL/CSA); 500 V 6kV/3 (VDE) or 600 V (UL/CSA) with two-tier rail terminal blocks; 5 break points, 3 x podis tray cable, 2 x round cable M20 / M25; black.

Description	Type	Part No.	PU
Distribution module	FCS 4 7 SA SA SW	75.010.0053.1	1

TECHNICAL DATA	
Rated voltage (V)	500 / 600 for UL
Rated current (A)	32 / 30 for USA / 25 for Canada
Number of poles	7
Connection type 1	Screw connection
Connection type 2	Screw connection
Min. rated cross section, finely stranded (mm ²)	1.5
Max. rated cross section, finely stranded (mm ²)	4
Color	Black
Degree of protection	IP65
Length (mm)	175
Width (mm)	83
Height (mm)	78
Certificates / Approvals	UL Listed (E480715) and cURus (E247489)

PODIS® CON

PLUG-IN OUTGOING FEEDERS FOR 7G4

Tray cable outgoing feeder plug-in, 7 pole



Tray cable outgoing feeder podis® CON, plug-in FCS 4 7 SI BU SW; 7-pole, 20 A; 277/480 V 4kV/3 (VDE); 600 V (UL, CSA); socket with plastic locking bracket; degree of protection IP65 plugged or with protective cap 07.409.7256.0; black.

Description	Type	Part No.	PU
Tray cable outgoing feeder	FCS 4 7 SI BU SW	75.015.5153.1	1

TECHNICAL DATA	
Rated voltage (V)	500 / 600 for UL
Rated voltage Auxiliary power (V)	50
Rated current (A)	20
Number of poles	7
Connection type 1	Penetration connection
Connection type 2	Plug connection
Min. rated cross section, finely stranded (mm ²)	-
Max. rated cross section, finely stranded (mm ²)	-
Color	Black
Degree of protection	IP65
Length (mm)	120
Width (mm)	60
Height (mm)	55
Certificates / Approvals	UL Listed (E480715) and cURus (E247489)

Plug complete 7-pole



Plug podis® CON FCS 4.0 7 ST SA; 7-pole, pins, 20 A, 277/480 V 4kV/3 (VDE); 600 V (UL, CSA); with M25 threaded joint for round cables 9-16 mm; screw connection 4.0 mm²; degree of protection IP65; black

Description	Type	Part No.	PU
Plug complete	FCS 4 7 ST SA S00	75.015.0151.0	1

TECHNICAL DATA	
Rated voltage (V)	500 / 600 for UL
Rated voltage Auxiliary power (V)	50
Rated current (A)	20
Number of poles	7
Connection type 1	Plug connection
Connection type 2	Screw connection
Min. rated cross section, finely stranded (mm ²)	1.5
Max. rated cross section, finely stranded (mm ²)	4
Color	Black
Degree of protection	IP65
Length (mm)	94
Width (mm)	57
Height (mm)	79
Certificates / Approvals	UL Listed (E480715) and cURus (E247489)

Cover BAS AD DA 16



Protective cover without locking levers, without gasket size 16 for tray cable outgoing feeder 75.015.5153.1.

Description	Type	Part No.	PU
Cover	BAS AD DA 16	07.409.7256.0	1

PODIS® CON

PLUG-IN OUTGOING FEEDERS FOR 7G4

Plug complete

7-pole



podis® CON plug F+CS 4.0 7 ST SA; 7-pole, pins, 20 A, 277/480 V 4kV/3(VDE); 600 V (UL, CSA), with threaded connector M25 for threaded joint; screw connection 4,0 mm²; protection class IP65; black.

Description	Type	Part No.	PU
Plug complete	FCS 4 7 ST SA SO2	75.015.0151.2	1

TECHNICAL DATA	
Rated voltage (V)	500/600 for UL
Rated voltage Auxiliary power (V)	50
Rated current (A)	20
Number of poles	7
Connection type 1	Plug connection
Connection type 2	Screw connection
Min. rated cross section, finely stranded (mm ²)	1.5
Max. rated cross section, finely stranded (mm ²)	4
Color	Black
Degree of protection	IP65
Length (mm)	94
Width (mm)	57
Height (mm)	79
Certificates / Approvals	UL Listed (E480715) and cURus (E247489)

Mounting case

7-pole



podis® CON mounting plug FCS 4.0 7 ST SA SU; 7-pole, pins, 20 A, 277/480 V 4kV/3 (VDE); 600 V (UL, CSA), for podis outgoing feeder module 75.015.5153.1 screw connection 4.0 mm²; degree of protection IP65 in plugged state; black

Description	Type	Part No.	PU
Mounting case	FCS 4 7 ST SA SU	75.015.1153.1	1

TECHNICAL DATA	
Rated voltage (V)	500
Rated voltage Auxiliary power (V)	50
Rated current (A)	20
Number of poles	7
Connection type 1	Plug connection
Connection type 2	Screw connection
Min. rated cross section, finely stranded (mm ²)	1.5
Max. rated cross section, finely stranded (mm ²)	4
Color	Black
Degree of protection	IP65
Length (mm)	113
Width (mm)	57
Height (mm)	39
Certificates / Approvals	cURus (E247489)

PODIS® CON

SERVICE SOCKETS ON THE POWER BUS 7G4

Plug

Schuko 16 A



podis® CON plug with light socket (blue); German standard; straight mounting; Schuko or CEE 7/4, 230 V, 16 A, 3-pole, IP54; Connected wire: L1 - 1; N - 4; PE - PE

Description	Type	Part No.	PU
Socket	FCS-CEE7/4 230V16A3P	83.315.0001.1	1

TECHNICAL DATA	
Nominal voltage (V)	230
Nominal current (A)	16
Type of voltage for the supply voltage	AC
Supply frequency	50
Number of poles	3
Connection type 1	Plug connection
Connection type 2	CEE 7/4 16A 3P
Color	Blue
Degree of protection (IP)	IP54
Length (mm)	115
Width (mm)	104
Height (mm)	115

Plug

CEE 3-pole, 16 A



podis® CON plug with CEE 6H socket (blue); German standard; straight mounting; CEE 6H, 230 V, 16 A, 3-pole, IP44; connected wire: L1 - 1; N - 4; PE - PE

Description	Type	Part No.	PU
Socket	FCS-CEE6H 230V16A3P	83.315.0001.2	1

TECHNICAL DATA	
Nominal voltage (V)	230
Nominal current (A)	16
Type of voltage for the supply voltage	AC
Supply frequency	50
Number of poles	3
Connection type 1	Plug connection
Connection type 2	CEE 6H 16A
Color	Blue
Degree of protection (IP)	IP44
Length (mm)	115
Width (mm)	104
Height (mm)	160

PODIS® CON

SERVICE SOCKETS ON THE POWER BUS 7G4

Plug
CEE 5-pole, 16 A



podis® CON plug with CEE socket; straight mounting; 230/400 V AC; 240/415 V AC; 16 A - 6h, 3P+N+PE; 50/60 Hz; IP44; connected wire: L1 - 1; L2 - 2; L3 - 3; N - 4; PE - PE

Description	Type	Part No.	PU
Socket	FCS-CEE6H 400V16A5P	83.315.0002.1	1

TECHNICAL DATA	
Nominal voltage (V)	400
Nominal current (A)	16
Type of voltage for the supply voltage	AC
Supply frequency	50
Number of poles	5
Connection type 1	Plug connection
Connection type 2	CEE 6H 16A 5P
Color	red
Degree of protection (IP)	IP44
Length (mm)	115
Width (mm)	104
Height (mm)	160

PODIS® CON

PRE-ASSEMBLED CONNECTION AND INTERCONNECTING CABLES 7G4

Connection cable Plug – open end



podis® CON connection cable FCS 2.5 7 STSA-10; plug assembled with round cable 7 x 2.5 mm², open cable end; stripping length 130 mm; insulation removal length 7 mm, ultrasonically compressed; cable length 1000 mm; black

Description	Type	Part No.	PU
Connection cable	FCS 2,5 7 STSA - 10	83.301.1020.1	1

TECHNICAL DATA			
Rated voltage (V)			400
Rated current (A)			20
Number of poles			7
Cable cross-section (mm ²)			2.5
Design side 1			Plug
Design side 2			Open end
Cable end treatment			ultrasonically compressed wire ends
Cable type			Ölflex Classic 110
Cable diameter (mm)			11.1
Stripping length (mm)			130
Wire strip length (mm)			7
Cable length (m)			1.0
Certificates / Approvals			-

Versions	Type	Part No.	PU	
Cable length (m)	2.0	FCS 2,5 7 STSA - 20	83.301.2020.1	1
	3.0	FCS 2,5 7 STSA - 30	83.301.3020.1	1
	4.0	FCS 2,5 7 STSA - 40	83.301.4020.1	1
	5.0	FCS 2,5 7 STSA - 50	83.301.5020.1	1
	6.0	FCS 2,5 7 STSA - 60	83.301.6020.1	1
	7.0	FCS 2,5 7 STSA - 70	83.301.7020.1	1
	8.0	FCS 2,5 7 STSA - 80	83.301.8020.1	1
	9.0	FCS 2,5 7 STSA - 90	83.301.9020.1	1

Connection cable UL-execution Plug – open end



podis® CON connection cable FCS AWG14 7 STSA-10; plug assembled with round cable “Ölflex Control TM 7G AWG 14”; open cable end; stripping length 130 mm; insulation removal length 7 mm, ultrasonically compressed; cable length 1000 mm

Description	Type	Part No.	PU
Connection cable	FCS AWG14 7 STSA - 10	83.301.1040.1	1

TECHNICAL DATA			
Nominal voltage (V)			600
Nominal current (A)			16
Cable cross-section (AWG)			14
Number of poles			7
Design side 1			Plug
Design side 2			Open end
Cable end treatment			ultrasonically compressed wire ends
Cable type			Ölflex Control TM
Cable diameter (mm)			11.6
Stripping length (mm)			130
Wire strip length (mm)			7
Cable length (m)			1.0
Certificates / Approvals			-

Versions	Type	Part No.	PU	
Cable length (m)	2.0	FCS AWG14 7 STSA - 20	83.301.2040.1	1
	3.0	FCS AWG14 7 STSA - 30	83.301.3040.1	1
	4.0	FCS AWG14 7 STSA - 40	83.301.4040.1	1
	5.0	FCS AWG14 7 STSA - 50	83.301.5040.1	1
	6.0	FCS AWG14 7 STSA - 60	83.301.6040.1	1
	7.0	FCS AWG14 7 STSA - 70	83.301.7040.1	1
	8.0	FCS AWG14 7 STSA - 80	83.301.8040.1	1
	9.0	FCS AWG14 7 STSA - 90	83.301.9040.1	1

PODIS® CON

PRE-ASSEMBLED CONNECTION AND INTERCONNECTING CABLES 7G4

Interconnecting cable Plug - Connection module



podis® CON interconnecting cable FCS 2.5 7 STSA SIFK 10; plug assembled with round cable 7 x 2.5 mm², connection module; cable length 1000 mm; black

Description	Type	Part No.	PU
Interconnecting cable	FCS 2,5 7 STSA - SIFK10	83.302.1025.1	1

TECHNICAL DATA			
Rated voltage (V)		400	
Rated current (A)		20	
Number of poles		7	
Cable cross-section (mm ²)		2.5	
Design side 1		Plug	
Design side 2		Connection module	
Cable end treatment		-	
Cable type		Ölflex Classic 110	
Cable diameter (mm)		11.1	
Stripping length (mm)		-	
Wire strip length (mm)		-	
Cable length (m)		1.0	
Certificates / Approvals		-	

Versions	Type	Part No.	PU	
Cable length (m)	2.0	FCS 2,5 7 STSA SIFK - 20	83.302.2025.1	1
	3.0	FCS 2,5 7 STSA SIFK - 30	83.302.3025.1	1
	4.0	FCS 2,5 7 STSA SIFK - 40	83.302.4025.1	1
	5.0	FCS 2,5 7 STSA SIFK - 50	83.302.5025.1	1
	6.0	FCS 2,5 7 STSA SIFK - 60	83.302.6025.1	1
	7.0	FCS 2,5 7 STSA SIFK - 70	83.302.7025.1	1
	8.0	FCS 2,5 7 STSA SIFK - 80	83.302.8025.1	1
	9.0	FCS 2,5 7 STSA SIFK - 90	83.302.9025.1	1

Interconnecting cable Connection module - Connection module



podis® CON interconnecting cable FCS 4 7 SIFK SIFK 10; connection module assembled with round cable 7 x 4 mm², connection module; cable length 1000 mm; black

Description	Type	Part No.	PU
Interconnecting cable	FCS 4 7 SIFK SIFK 10	83.303.1039.1	1

TECHNICAL DATA			
Rated voltage (V)		500	
Rated current (A)		20	
Number of poles		7	
Cable cross-section (mm ²)		4	
Design side 1		Connection module	
Design side 2		Connection module	
Cable end treatment		-	
Cable type		Ölflex Classic 110	
Cable diameter (mm)		13.4	
Stripping length (mm)		-	
Wire strip length (mm)		-	
Cable length (m)		1.0	
Certificates / Approvals		-	

Versions	Type	Part No.	PU	
Cable length (m)	2.0	FCS 2,5 7 SIFK SIFK - 20	83.303.2039.1	1
	3.0	FCS 2,5 7 SIFK SIFK - 30	83.303.3039.1	1
	4.0	FCS 2,5 7 SIFK SIFK - 40	83.303.4039.1	1
	5.0	FCS 2,5 7 SIFK SIFK - 50	83.303.5039.1	1
	6.0	FCS 2,5 7 SIFK SIFK - 60	83.303.6039.1	1
	7.0	FCS 2,5 7 SIFK SIFK - 70	83.303.7039.1	1
	8.0	FCS 2,5 7 SIFK SIFK - 80	83.303.8039.1	1
	9.0	FCS 2,5 7 SIFK SIFK - 90	83.303.9039.1	1

PODIS® CON

PRE-ASSEMBLED CONNECTION AND INTERCONNECTING CABLES 7G4

Connection cable

Connection module - open end

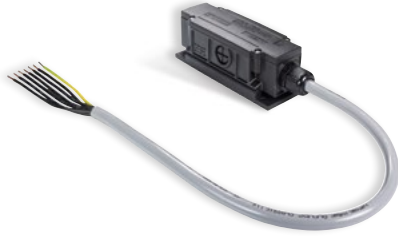

podis® CON connection cable FCS 4 7 SIFK - 10; podis connection module assembled with round cable 7 x 4 mm², open cable end; stripping length 130 mm; insulation removal length 7 mm, ultrasonically compressed; black

Description	Type	Part No.	PU
Interconnecting cable	FCS 4 7 SIFK - 10	83.304.1030.1	1

TECHNICAL DATA			
Rated voltage (V)		500	
Rated current (A)		20	
Number of poles		7	
Cable cross-section (mm ²)		4	
Design side 1		Connection module	
Design side 2		Open end	
Cable end treatment		ultrasonically compressed wire ends	
Cable type		Ölflex Classic 110	
Cable diameter (mm)		13.4	
Stripping length (mm)		130	
Wire strip length (mm)		7	
Cable length (m)		1.0	
Certificates / Approvals		-	

Versions	Type	Part No.	PU	
Cable length (m)	2.0	FCS 4 7 SIFK - 20	83.304.2030.1	1
	3.0	FCS 4 7 SIFK - 30	83.304.3030.1	1
	4.0	FCS 4 7 SIFK - 40	83.304.4030.1	1
	5.0	FCS 4 7 SIFK - 50	83.304.5030.1	1
	6.0	FCS 4 7 SIFK - 60	83.304.6030.1	1
	7.0	FCS 4 7 SIFK - 70	83.304.7030.1	1
	8.0	FCS 4 7 SIFK - 80	83.304.8030.1	1
	9.0	FCS 4 7 SIFK - 90	83.304.9030.1	1

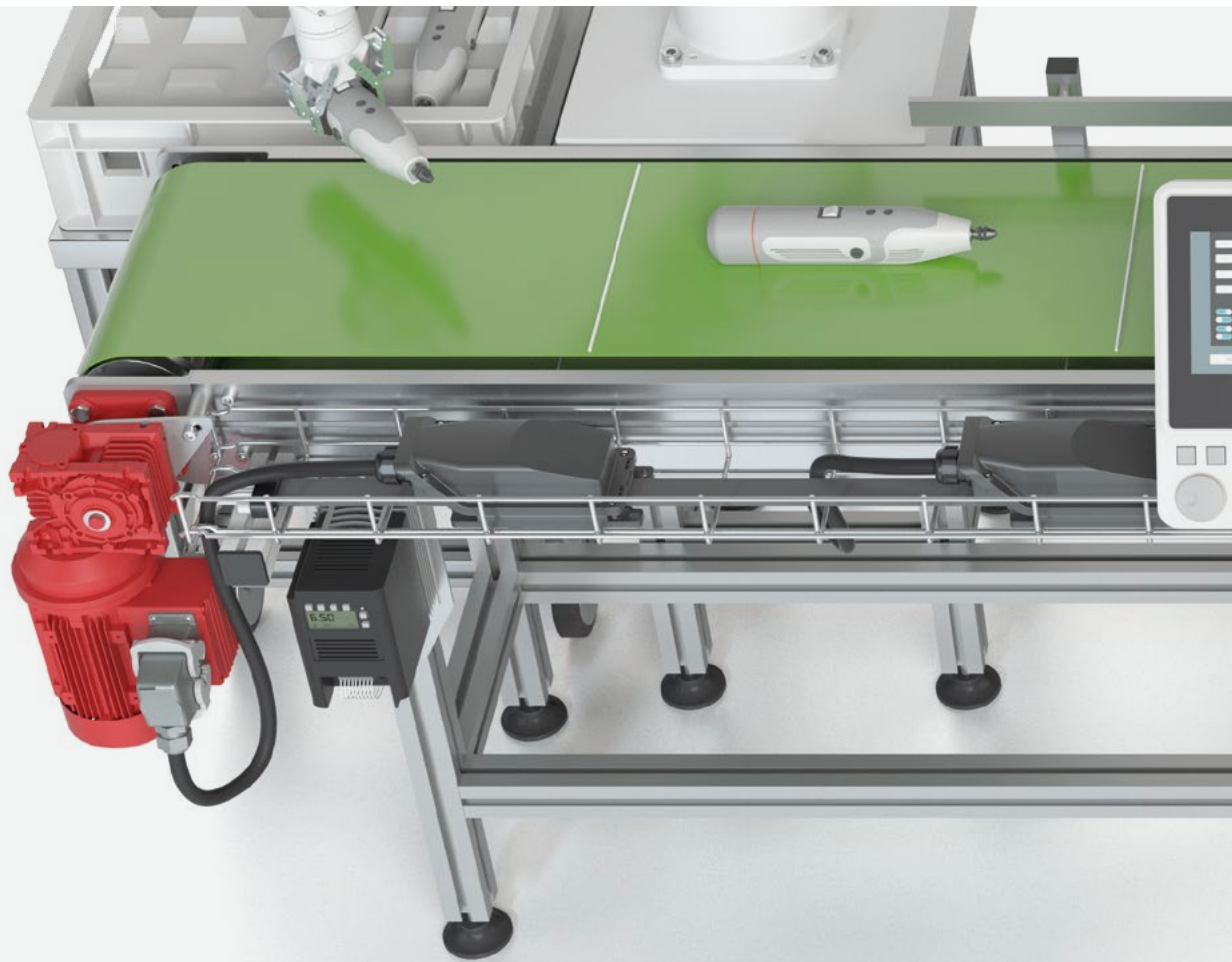

PODIS[®] MOTOR STARTER

Quick installation.



STEP 1

PLUG TOGETHER

Power, AS-i, and motor cable connection



STEP 2

CONFIGURE

Addressing via touchpanel, configuration via parameter download from the AS-i Master



STEP 3

... and start!

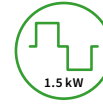

Direct, reversing or soft starters for asynchronous motors
from 0.09 to 1.5 kW



Considerable time saved during installation can be connected directly onto the power bus

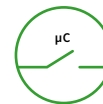

Electronic motor protection for optimum protection of your motors

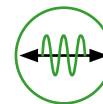

Parameter download for settings
shortens commissioning and maintenance



On-site diagnostics
status and error diagnostics right at the device



Maintenance-friendly
quick and easy replacement when required



Robust design
IP65 degree of protection for rough industrial environments

- + Space-saving design
- + Simple installation in or on the cable tray
- + Smart motor control
- + Simple operation, optimum diagnostics

PODIS[®] ELECTRONIC

Motor starter direct/reversing on the power bus.

In a particularly compact housing, the podis[®] MCU motor starter combines the function of the electronic motor starter with AS-i control and the integration of up to three sensors. They are used in applications in which standard three-phase motors up to 1.5 kW are started, optionally in one or two directions of rotation.

Direct starter

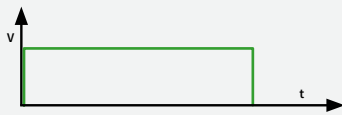

Reversible starter

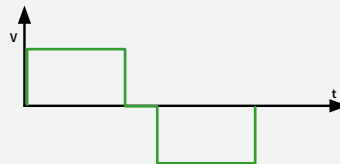

AS-i laid separately
Motor starter plugged directly on the power bus

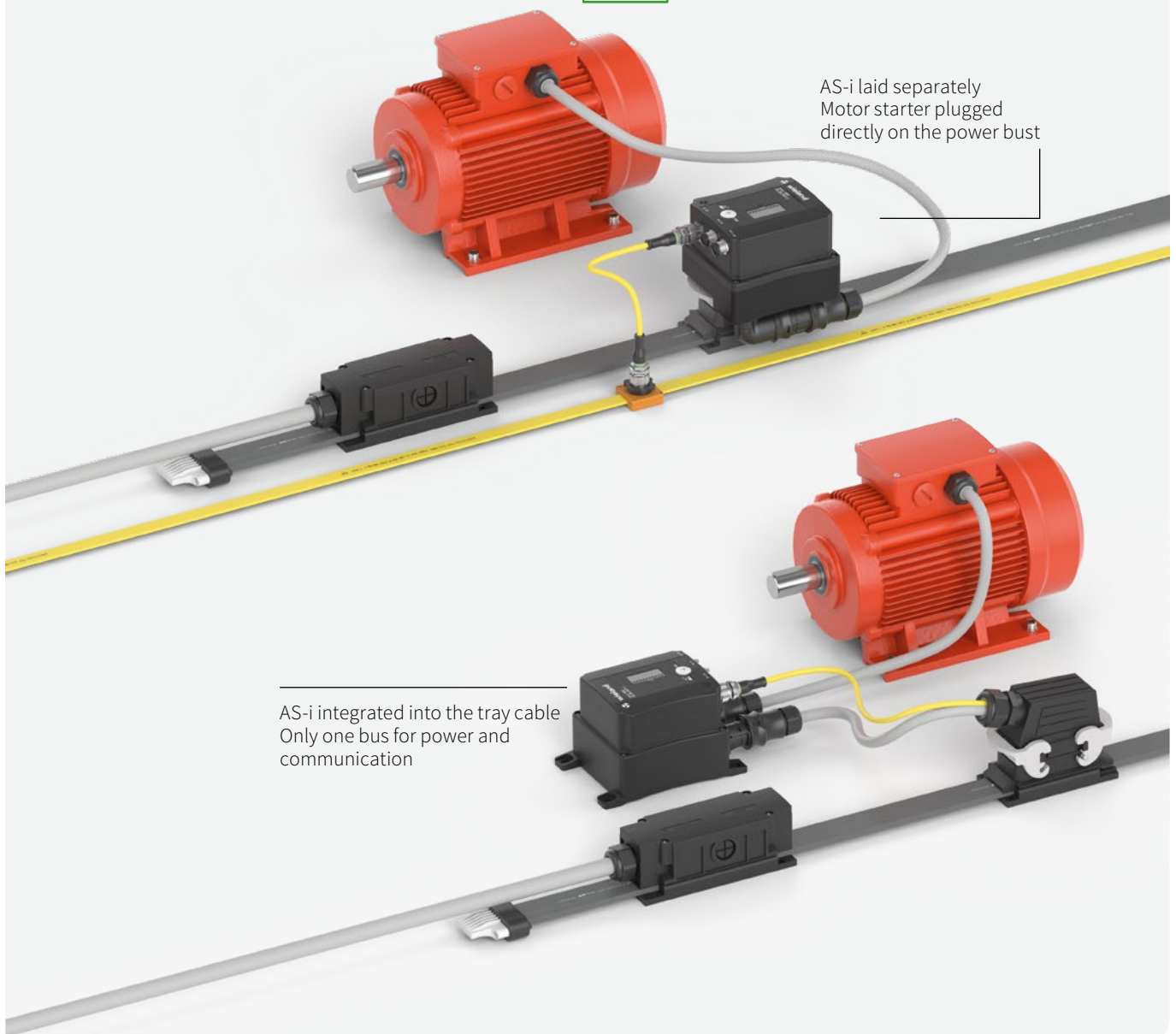

AS-i integrated into the tray cable
Only one bus for power and communication

PODIS® MCU · GESIS® MCU

MOTOR STARTER DIRECT/REVERSING

Direct/reversing starter
podis® MCU
FA C 3I/W1.5
 direct plug-in



podis® MCU FA C 3I/W1,5; FA C 3I/W1.5; reversing starter for three-phase asynchronous motors with electronic motor protection of 0.09-1.5 kW / 400 V AC; standard AS-i slave; AS-i specification 3.0 for 31 participants; auxiliary power from AS-i; 3 external digital initiator inputs via two M12 sockets; power (400 V) plug-in feed via podis outgoing tray cable FCS 4 7 SI BU (75.015.5153.1); AS-i via M12 socket; motor output via RST20i5 black, socket; parameterization of nominal motor current, minimum current, current asymmetry, reversing break, blocking of rotational direction (direct starter) via parameter download AS-i; diagnosis on the device via LED or AS interface

Description	Type	Part No.	PU
Direct/reversing starter	FA C 3I/W1,5	83.222.0009.5	1

TECHNICAL DATA	
Supply voltage of AC 50 Hz (V)	400
Supply voltage - voltage type	AC
Rated operating current of the motor (A)	4.0
Nominal power of the motor (min.- max.) (kW)	0.09 - 1.5
Frequency range (Hz)	50 - 60
Number of inputs	3
Number of motor outputs	1
AS-i specification	V3.0
Slave Type	Standard-Slave
Current consumption of AS-i (mA)	max. 200
Motor current parameterization available	Yes
Brake activation	no
Motor protection via thermistor	no
Motor protection via thermal motor model	Yes
Switching rate	max. 1000/h
Conductor connection power feed-in	podis® CON plug connection
Connection type AS-i	Plug connection M12
Connection type Sensors	Plug connection M12
Connection type Motor output	Plug connection RST20i5
Degree of protection	IP65
Wall mounting	Yes
Mounting orientation	horizontal and vertical
Ambient temperature	-20...+40 °C (>40 °C Derating)
W x H x D (mm) of FCS 4 7 SI BU	104x139x134
Certificates / Approvals	-

Direct/reversing starter
gesis® MCU
PA V 3I/W1.5
 remote



gesis® MCU PA V 3I/W1.5; reversing starter for three-phase asynchronous motors with electronic motor protection of 0.09-1.5 kW / 400 V AC; standard AS-i slave; AS-i specification 3.0 for 31 participants; auxiliary power from AS-i; 3 external digital initiator inputs via two M12 sockets; power (400 V) feed-in via RST 20i5 black, plug; motor output via RST 20i5 black, socket; parameterization of nominal motor current, minimum current, current asymmetry, reversing break, blocking of rotational direction (direct starter) via parameter download AS-i; diagnosis on the device via LED or AS interface

Description	Type	Part No.	PU
Direct/reversing starter	PA V 3I/W1,5	83.234.0009.5	1

TECHNICAL DATA	
Supply voltage of AC 50 Hz (V)	400
Supply voltage - voltage type	AC
Rated operating current of the motor (A)	4.0
Nominal power of the motor (min.- max.) (kW)	0.09 - 1.5
Frequency range (Hz)	50 - 60
Number of inputs	3
Number of motor outputs	1
AS-i specification	V3.0
Slave Type	Standard-Slave
Current consumption of AS-i (mA)	max. 200
Motor current parameterization available	Yes
Brake activation	no
Motor protection via thermistor	no
Motor protection via thermal motor model	Yes
Switching rate	max. 1000/h
Conductor connection power feed-in	Plug connection RST20i5
Connection type AS-i	Plug connection M12
Connection type Sensors	Plug connection M12
Connection type Motor output	Plug connection RST20i5
Degree of protection	IP65
Wall mounting	Yes
Mounting orientation	horizontal and vertical
Ambient temperature	-20...+40 °C (>40 °C Derating)
W x H x D (mm)	104x96x161
Certificates / Approvals	-

PODIS[®] ELECTRONIC

Motor soft starter on the power bus.

The new electronic podis[®] MSS motor soft starter is for starting and stopping three-phase asynchronous motors gently. To ensure that light conveyor goods do not slip when the motor is started and to take care of the mechanical components of the drive, the soft starter switches the drive on and off gently.

The acceleration time, deceleration time, and breakaway torque are smoothly adjustable.

Soft starter

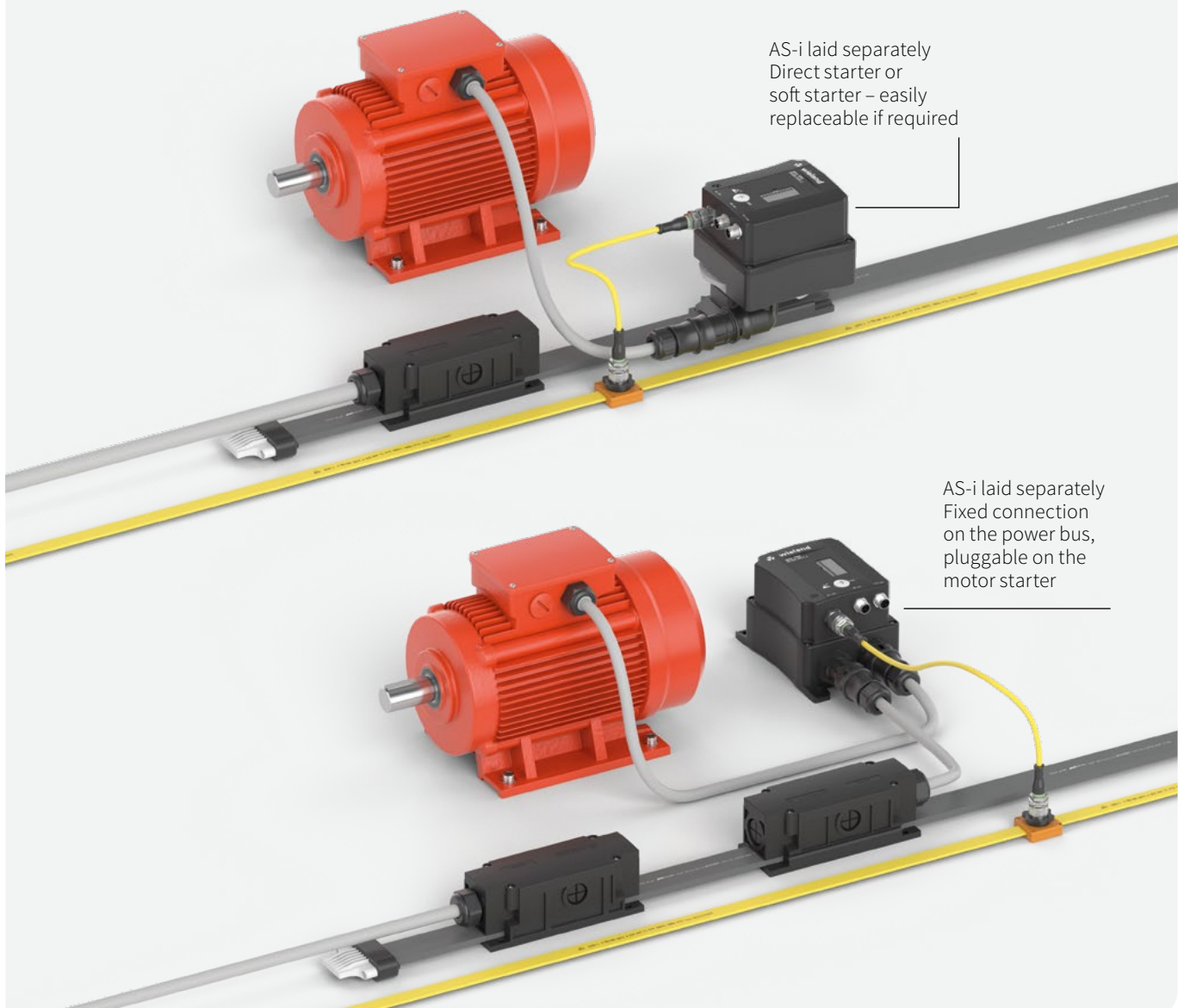
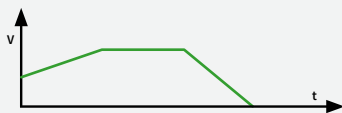

PODIS® MSS · GESIS® MSS

MOTOR SOFT STARTER

Soft starter podis® MSS FA C 3I/W1,5 direct plug-in



podis® MSS FA C 3I/W1,5; soft starter with reversing function for three-phase asynchronous motors of 0.09-1.5 kW / 400 V AC; standard AS-i slave; AS-i specification 3.0 for 31 participants; auxiliary power from AS-i; 3 external digital initiator inputs via two M12 sockets; power (400 V) infeed via podis® CON tray cable outgoing feeder (75.015.5153.1) pluggable; motor output via RST20i5 black, socket; function: Soft starting and stopping; reversing function; electronic motor protection; parameterization of nominal motor current, ramp-up time/deceleration time; minimum current, current asymmetry, reversing break, blocking of rotational direction (direct starter) via parameter download AS-i; diagnosis on the device via LED or via AS-Interface

Description	Type	Part No.	PU
Soft starter	FA C 3I/W1,5	83.223.0009.5	1

TECHNICAL DATA	
Supply voltage of AC 50 Hz (V)	400
Supply voltage - voltage type	AC
Rated operating current of the motor (A)	4.0
Nominal power of the motor (min.- max.) (kW)	0.09 - 1.5
Frequency range (Hz)	50
Number of inputs	3
Number of motor outputs	1
AS-i specification	V3.0
Slave Type	Standard-Slave
Current consumption of AS-i (mA)	max. 200
Motor current parameterization available	Yes
Starting voltage	0 - 100%
Starting time / Deceleration time	0.1 - 10s
Brake activation	no
Motor protection via thermistor	no
Motor protection via thermal motor model	Yes
Switching rate max.	1000/h
Conductor connection power feed-in	Plug connection podis con
Connection type AS-i / Sensors	Plug connection M12
Connection type Motor output	Plug connection RST20i5
Degree of protection	IP65
Wall mounting	Yes
Mounting orientation	horizontal and vertical
Ambient temperature	-20...+40 °C (>40 °C Derating)
W x H x D (mm) of FCS 4 7 SI BU	104x139x152
Certificates / Approvals	-

Soft starter gesis® MSS PA V 3I/W1,5 remote



gesis® MSS PA V 3I/W1,5; soft starters with reversing function for three-phase asynchronous motors of 0.09 - 1.5 kW / 400 V AC; standard AS-i slave; AS-i specification 3.0 for 31 participants; auxiliary power from AS-i; 3 external digital initiator inputs via two M12 sockets; power (400 V) infeed via RST20i5 black, plug; motor output via RST20i5 black, socket; function: Soft starting and stopping; reversing function; electronic motor protection; parameterization of nominal motor current, ramp-up time/deceleration time; minimum current, current asymmetry, reversing break, blocking of rotational direction (direct starter) via parameter download AS-i; diagnosis on the device via LED or via AS-Interface

Description	Type	Part No.	PU
Soft starter	PA V 3I/W1,5	83.235.0009.5	1

TECHNICAL DATA	
Supply voltage of AC 50 Hz (V)	400
Supply voltage - voltage type	AC
Rated operating current of the motor (A)	4.0
Nominal power of the motor (min.- max.) (kW)	0.09 - 1.5
Frequency range (Hz)	50
Number of inputs	3
Number of motor outputs	1
AS-i specification	V3.0
Slave Type	Standard-Slave
Current consumption of AS-i (mA)	max. 200
Motor current parameterization available	Yes
Starting voltage	0 - 100%
Starting time / Deceleration time	0.1 - 10s
Brake activation	no
Motor protection via thermistor	no
Motor protection via thermal motor model	Yes
Switching rate max.	1000/h
Conductor connection power feed-in	Plug connection RST20i5
Connection type AS-i / Sensors	Plug connection M12
Connection type Motor output	Plug connection RST20i5
Degree of protection	IP65
Wall mounting	Yes
Mounting orientation	horizontal and vertical
Ambient temperature	-20...+40 °C (>40 °C Derating)
W x H x D (mm)	108x96x161
Certificates / Approvals	-

PODIS® ELECTRONIC

Maintenance switch on the power bus.

To activate the drives safely to carry out a repair or maintenance, maintenance switches installed “on-site” can separate individual conveying lines or consumers from the network without having to shut down the entire plant.

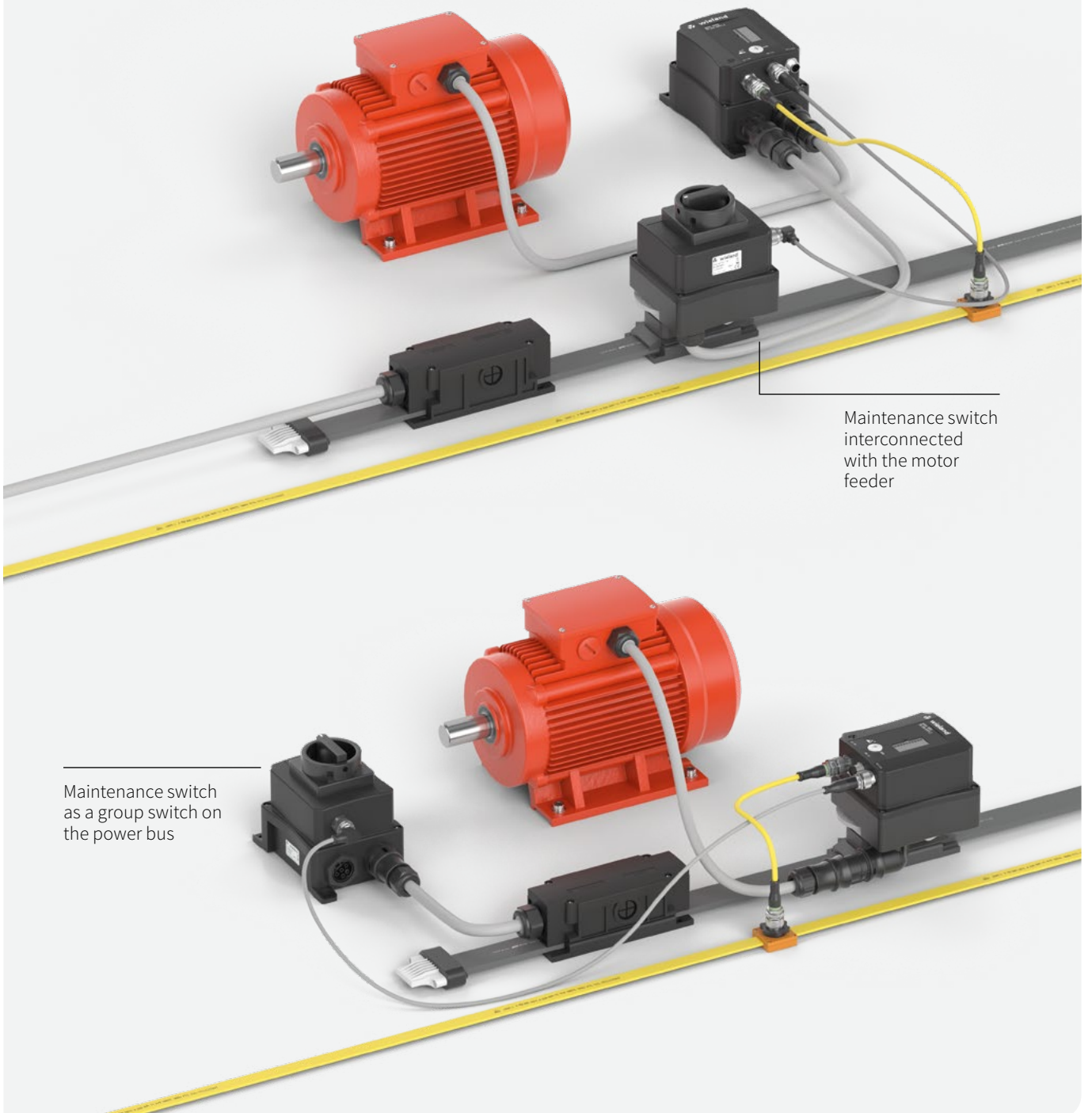

PODIS® SWITCH · GESIS® SWITCH MAINTENANCE SWITCH

Maintenance switch
podis® SWITCH
F CM 3P1S 25A
direct plug-in



podis® SWITCH F CM 3P1S 25A; podis® CON plug with maintenance switch; 400 V AC, 3-pole with additional auxiliary contact; switch position indicator on M12 plug; rated continuous current I_n = 25 A; switching capacity according to AC23A/B = 11 kW / 400 V; according to AC3 = 7.5 kW / 400 V

Description	Type	Part No.	PU
Maintenance switch	F CM 3P1S 25A	83.226.0009.5	1

TECHNICAL DATA	
Nominal voltage (V)	400
Nominal current (A)	25
Conductor connection power feed-in	podis® CON plug connection
Connection type output	Plug connection RST20i5
Degree of protection	IP65
Wall mounting	Yes
Mounting orientation	horizontal and vertical
W x H x D (mm) of FCS 4 7 SI BU	104x171x132
Certificates / Approvals	-

TECHNICAL DATA SWITCH	
Operating voltage (V)	400
Rated current AC-23 A (A)	25
Rated power AC-23 A/B (kW)	11
Rated power AC-3 (kW)	7.5
Number of poles	3
Auxiliary contact switch position (M12)	Yes

Maintenance switch
gesis® SWITCH
P CM 3P1S 20A
remote



gesis® SWITCH P CM 3P1S 20A; RST distributor box with maintenance switch; 400 V AC, 3-pole with additional auxiliary contact; switch position indicator on M12 plug; rated continuous current I_n = 20 A; switching capacity according to AC23A/B = 11 kW / 400 V; according to AC3 = 7.5 kW / 400 V

Description	Type	Part No.	Part No.	PU
Maintenance switch	P CM 3P1S 20A	83.236.0009.5		1
Maintenance switch with UL	RST1i1+1o	83.236.0009.6		1

TECHNICAL DATA	
Nominal voltage (V)	400
Nominal current (A)	20
Conductor connection power feed-in	Plug connection RST20i5
Connection type output switched	Plug connection RST20i5
Connection type output power bus unswitched	Plug connection RST20i5
Degree of protection	IP65 (only for 83.236.0009.5)
Wall mounting	Yes
Mounting orientation	horizontal and vertical
W x H x D (mm)	104x168x130
Certificates / Approvals	-

TECHNICAL DATA SWITCH	
Operating voltage (V)	400
Rated current AC-23 A (A)	25
Rated power AC-23 A/B (kW)	11
Rated power AC-3 (kW)	7.5
Number of poles	3
Auxiliary contact switch position (M12)	Yes

PODIS® CON

PRE-ASSEMBLED CONNECTION AND INTERCONNECTING CABLES MOTOR STARTER

Interconnecting cable for Power



Interconnecting cable podis® CON FCS1,5 5SIFK_RST 20i5 -05 for connection of gesis® MCU motor starter to the podis® power bus; assembled with "Ölflex Classic 110", 5G1.5 mm² for power; podis® CON connection module - RST 20i5; cable length 500 mm.

Description	Type	Part No.	PU
Interconnecting cable	FCS1,5 5SIFK_RST-05	83.307.0501.1	1

TECHNICAL DATA			
Rated voltage (V)		400	
Rated current (A)		20	
Number of poles		5	
Cable cross-section (mm ²)		1.5	
Design side 1		Connection module	
Design side 2		2x Socket	
Cable type		Ölflex Classic 110 5G1.5	
Cable diameter (mm)		8.1	
Cable length (m)		0.5	

Versions	Type	Part No.	PU	
Cable length (m)	1.0	FCS1,5 5SIFK_RST-10	83.307.1001.1	1
	1.5	FCS1,5 5SIFK_RST-15	83.307.1501.1	1
	3.0	FCS1,5 5SIFK_RST-30	83.307.3001.1	1
	5.0	FCS1,5 5SIFK_RST-50	83.307.5001.1	1

AS-i pick-off M12



AS-i pick-off M12; can be used as pick-off distributor or plug, re-usable penetration technique acc. to IEC 68 and DIN 41611.

Description	Type	Part No.	PU
AS-i pick-off M12		83.209.2201.0	1

PODIS® CON

PRE-ASSEMBLED CONNECTION AND INTERCONNECTING CABLES MOTOR STARTER

Motor connection cable podis® MCU / gesis® MCU



Round pluggable connector, assembled with cable "Ölflex Classic 110" 5G1.5, plug on one side / free end on the other, cable cross-section: 1.5 mm², color: pluggable connector black, cable black, system: RST 20/4KS-S 150 10SW, total length: 1000 mm.

Description	Type	Part No.	PU
Assembled cable	RST20i4KS-S 150 10SW	96.442.1084.1	1

TECHNICAL DATA

Rated voltage (V)		400
Rated current (A)		20
Number of poles		4
Cable cross-section (mm ²)		1.5
Design side 1		Plug
Design side 2		Open end
Cable end treatment		ultrasonically compressed wire ends
Cable type		Ölflex Classic 110 4G1.5
Cable diameter (mm)		7.2
Stripping length (mm)		35
Wire strip length (mm)		9
Cable length (m)		1.0

Versions	Type	Part No.	PU	
Cable length (m)	2.0	RST20i4KS-S 150 20SW	96.442.2084.1	1
	3.0	RST20i4KS-S 150 30SW	96.442.3084.1	1
	4.0	RST20i4KS-S 150 40SW	96.442.4084.1	1
	5.0	RST20i4KS-S 150 50SW	96.442.5084.1	1
	6.0	RST20i4KS-S 150 60SW	96.442.6084.1	1
	7.0	RST20i4KS-S 150 70SW	96.442.7084.1	1
	8.0	RST20i4KS-S 150 80SW	96.442.8084.1	1
	9.0	RST20i4KS-S 150 90SW	96.442.9084.1	1

AS-i-branch cable



AS-i branch cable M12 plug straight on socket straight; length 300 mm.

Description	Type	Part No.	PU
AS-i-branch cable		83.209.2203.0	1

PODIS® MOT

Field distributors for the uncut tray cable power bus

The podis® MOT field distributors connect remotely controlled drives with the feeding power supply, the 24 V control voltage, and the field bus. They are based on the bus interface technology with additional connecting technology for power distribution. Mounting the field distributors close to the motors facilitates distributed installation.

The field distributors are optimally compatible with SEW MOVIMOT and MOVI-SWITCH drives for efficient and flexible distribution of your system. In addition, up to three sensors can be connected to the extremely compact housings. Field distributors for the uncut podis® SWITCH devices activate any single-phase loads such as flaps, magnetic valves, lifting magnets, and alterable switches. Sensors and actuators can be connected to the field bus via the podis® I/O input or output modules.



podis® MOT FA CP ...
Plug-in on the field distributor

FEATURES

- + Integrated power distribution and field bus interface
- + AS interface or PROFIBUS DP
- + Digital inputs on M12
- + Optional maintenance switch
- + Connection of drive via a pre-assembled connection cable
- + Plug-in on the drive or field distributor
- + Detailed diagnosis via LED displays

PODIS® MOT

FIELD DISTRIBUTORS FOR AS INTERFACE (BINARY/RS485 INTERFACE TO THE DRIVE)

FIELD DISTRIBUTOR FA CP31/1140 (binary)



podis®MOT FA CP 31/1140; field distributor at the AS-i for distributed loads (e.g. MOVIMOT or MOVI-SWITCH from SEW) on the podis power bus with degree of protection IP65, standard AS-i slave; power (400 V AC) + control (24 V, 0 V, 4 control outputs, 1 input) plug-in via revosMOT 11 pole, 3 digital initiator inputs on M12, AS-i connection via M12.

Description	Type	Part No.	PU
Field distributor	FA CP31/1140	83.210.0005.2	1

TECHNICAL DATA	
Rated voltage (V AC)	400
Rated current (A)	16
Rated operating voltage auxiliary power (V DC)	24
Rated operating current auxiliary power (A)	2
Number of inputs	4
Number of outputs	4
Output current per channel (A)	0.5
Output type	Transistor
AS-i specification	V2.11
Power bus connection type	Piercing connection
Connection type Sensors	Plug connection
Connection type Motor output	Plug connection
L x W x H (mm)	160 x 70.5 x 79.5
Certificates / Approvals	

FIELD DISTRIBUTOR FA CP 31/RS485 at the AS-i



podis®MOT FA CP 31/RS485(SEW); field distributor at the AS-i for distributed loads (MOVIMOT from SEW) on the podis® power bus with degree of protection IP65, standard AS-i slave; power (400 V AC) + control (24 V, 0 V, serial interface RS485 – MOVILINK protocol); plug-in to the load via revosMOT pluggable connector (11 pole), 3 digital initiator inputs on M12, AS-i connection via M12.

Description	Type	Part No.	PU
Field distributor	FA CP 31/RS485 (SEW)	83.214.0005.2	1

TECHNICAL DATA	
Rated voltage (V AC)	400
Rated current (A)	16
Rated operating voltage auxiliary power (V DC)	24
Rated operating current auxiliary power (A)	1
Number of inputs	3
Number of outputs	-
Number of HW interfaces serial RS485	1
AS-i specification	V2.11
Power bus connection type	Piercing connection
Connection type Sensors	Plug connection
Connection type Motor output	Plug connection
L x W x H (mm)	172 x 70.5 x 79.5
Certificates / Approvals	

PODIS® MOT

ASSEMBLED MOTOR CONNECTION CABLES

(BINARY INTERFACE)

Connection cable for MOVI-SWITCH 1E drives binary



Connection cable revos MOT 8 x 1.5 mm² revos mot W25 – 10; e.g. for SEW MOVI-SWITCH 1E, assembled with "Ölflex Classic 110"; 8 x 1.5 mm²; revos MOT angled – open cable end; stripping length 190 mm; insulation removal length 7 mm, ultrasonically compressed; cable length 1000 mm.

Description	Type	Part No.	PU
Connection cable	revos MOT W 8X1,5 - 10	83.311.1002.1	1

TECHNICAL DATA			
Rated voltage (V)		400	
Rated current (A)		16	
Number of poles		8	
Cable cross-section (mm ²)		1.5	
Design side 1		Plug	
Design side 2		Open end	
Cable end treatment		ultrasonically compressed wire ends	
Cable type		Ölflex Classic 110	
Cable diameter (mm)		10.6	
Stripping length (mm)		190	
Wire strip length (mm)		7	
Cable length (m)		1.0	
Certificates / Approvals		-	

Versions	Type	Part No.	PU	
Cable length (m)	1.5	revos MOT W 8X1,5 - 15	83.311.1502.1	1
	2.0	revos MOT W 8X1,5 - 20	83.311.2002.1	1
	3.0	revos MOT W 8X1,5 - 30	83.311.3002.1	1
	4.0	revos MOT W 8X1,5 - 40	83.311.4002.1	1
	5.0	revos MOT W 8X1,5 - 50	83.311.5002.1	1

Connection cable for MOVI-SWITCH 2S drives binary



Connection cable revos MOT W 9 x 1.5 mm² – 10; e.g. for SEW MOVI-SWITCH 2S, assembled with "Ölflex Classic 110"; 9 x 1.5 mm²; revos MOT angled – open cable end; stripping length 190 mm; insulation removal length 7 mm, ultrasonically compressed; cable length 1000 mm.

Description	Type	Part No.	PU
Connection cable	revos MOT W 9X1,5 - 10	83.312.1002.1	1

TECHNICAL DATA			
Rated voltage (V)		400	
Rated current (A)		16	
Number of poles		9	
Cable cross-section (mm ²)		1.5	
Design side 1		Plug	
Design side 2		Open end	
Cable end treatment		ultrasonically compressed wire ends	
Cable type		Ölflex Classic 110	
Cable diameter (mm)		11.4	
Stripping length (mm)		190	
Wire strip length (mm)		7	
Cable length (m)		1.0	
Certificates / Approvals		-	

Versions	Type	Part No.	PU	
Cable length (m)	1.5	revos MOT W 9X1,5 - 15	83.312.1502.1	1
	2.0	revos MOT W 9X1,5 - 20	83.312.2002.1	1
	3.0	revos MOT W 9X1,5 - 30	83.312.3002.1	1
	4.0	revos MOT W 9X1,5 - 40	83.312.4002.1	1
	5.0	revos MOT W 9X1,5 - 50	83.312.5002.1	1

PODIS® MOT

ASSEMBLED MOTOR CONNECTION CABLES (BINARY INTERFACE)

Connection cable for MOVIMOT drives binary



Connection cable revosMOT W 11 x 1.5 mm² – 10; e.g. for SEW MOVIMOT, assembled with “Ölflex Classic 110”; 11 x 1.5 mm²; revosMOT angled – open cable end; stripping length 190 mm; insulation removal length 7 mm, ultrasonically compressed; cable length 1000 mm.

Description	Type	Part No.	PU
Connection cable	revosMOT W 11X1,5 - 10	83.313.1002.1	1

TECHNICAL DATA			
Rated voltage (V)		400	
Rated current (A)		16	
Number of poles		11	
Cable cross-section (mm ²)		1.5	
Design side 1		Plug	
Design side 2		Open end	
Cable end treatment		ultrasonically compressed wire ends	
Cable type		Ölflex Classic 110	
Cable diameter (mm)		12	
Stripping length (mm)		190	
Wire strip length (mm)		7	
Cable length (m)		1.0	
Certificates / Approvals		-	

Versions	Type	Part No.	PU	
Cable length (m)	1.5	revosMOT W 11X1,5 - 15	83.313.1502.1	1
	2.0	revosMOT W 11X1,5 - 20	83.313.2002.1	1
	3.0	revosMOT W 11X1,5 - 30	83.313.3002.1	1
	4.0	revosMOT W 11X1,5 - 40	83.313.4002.1	1
	5.0	revosMOT W 11X1,5 - 50	83.313.5002.1	1

PODIS® LED

Extremely efficient + low maintenance.

podis® LED is the reliable lighting solution for industrial use in harsh environments. With their robust housing and insensitivity to vibration, these lights are especially suitable for illuminating work areas and routes in plant and machinery, both inside and out. Our flexible mounting systems make it easy to install the luminaires.

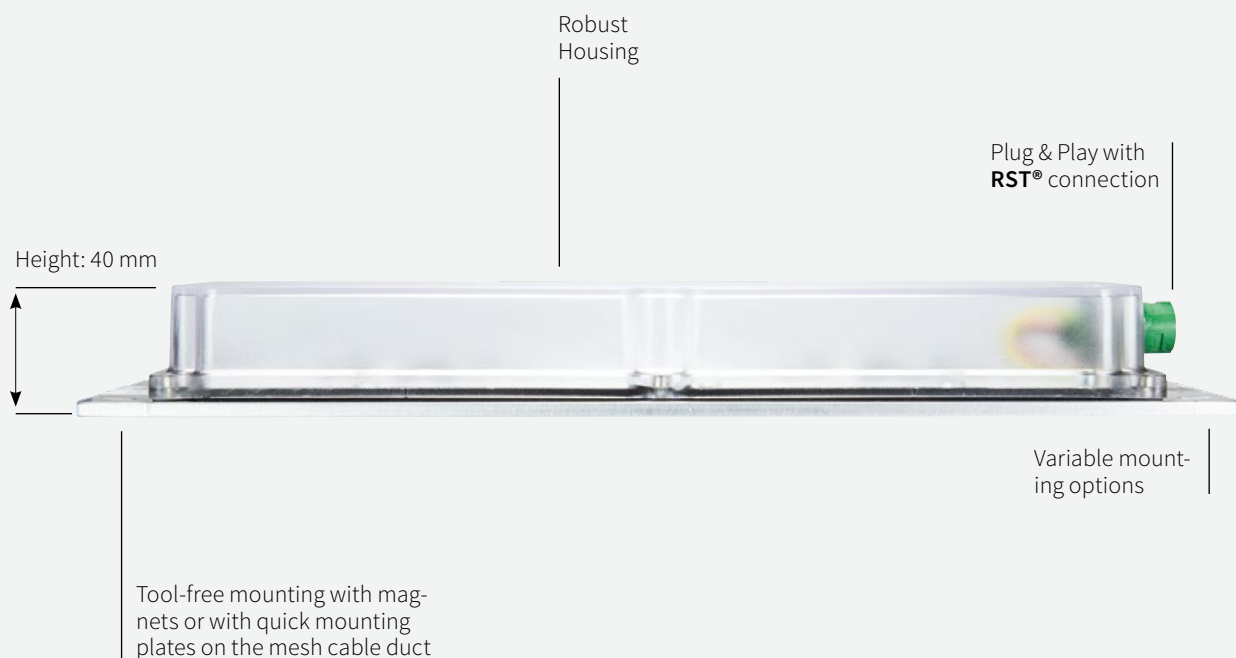

FEATURES

- + LED luminaire as plug+play component
- + Can be used as lighting + emergency lighting (DIN EN 60598-2-22)
- + Maintenance-free LED lights
- + Suitable for extreme temperature ranges (-40 °C to +70 °C)
- + 24 - 120 V DC or 230 V AC/DC



PODIS® LED

LUMINAIRES FOR THE VOLTAGE RANGE 24 - 120 V DC

LED-Luminaire FCS 24 V DC 5W



Description	Type	Part No.	PU
LED-Luminaire	FCS 24 V DC 5W	83.240.0010.0	1

TECHNICAL DATA

Min. nominal voltage	15 V DC
Max. nominal voltage	30 V DC
Lamp	LED
Operation mode	Continuous
Lamp output	4.9 W
Fuse	Device fuse
Reverse polarity protection	Yes
Emergency light marking	Z 1 ***
Light colour	6500 K
Ambient temperature ta min.	-40 °C
Ambient temperature ta max.	+70 °C
Storage temperature / transport min.	-40 °C
Storage temperature / transport max.	+70 °C
Standards	DIN EN 60598-1, DIN EN 60598-2-22
Installation type	Locked plug connection
Switching type	Maintained / non-maintained
Degree of protection (IP)	IP65
Power supply	podis® CON plug connection
W x H x D (mm) of FCS 4 7 BI BU	124x104x116
Certificates / Approvals	

LED-Luminaire FCS 24 V DC 5W/RST 20i2



Description	Type	Part No.	PU
LED-Luminaire	FCS 24 V DC 5W/ RST20i2	83.240.0011.0	1

TECHNICAL DATA

Min. nominal voltage	15 V DC
Max. nominal voltage	30 V DC
Lamp	LED
Operation mode	Continuous
Lamp output	4.9 W
Fuse	Device fuse
Reverse polarity protection	Yes
Emergency light marking	Z 1 ***
Light colour	6500 K
Ambient temperature ta min.	-40 °C
Ambient temperature ta max.	+70 °C
Storage temperature / transport min.	-40 °C
Storage temperature / transport max.	+70 °C
Standards	DIN EN 60598-1, DIN EN 60598-2-22
Installation type	Locked plug connection
Switching type	Maintained / non-maintained
Degree of protection (IP)	IP65
Power supply	podis® CON plug connection
W x H x D (mm) of FCS 4 7 BI BU	124x104x116
Certificates / Approvals	



PODIS® LED

LED-Luminaire podis® LED RST 24 V DC 5W



Description	Type	Part No.	PU
LED-Luminaire	podis® LED-Luminaire RST 24 V DC 5W	83.240.0030.0	1

TECHNICAL DATA

Min. nominal voltage	15 V DC
Max. nominal voltage	30 V DC
Lamp	LED
Operation mode	Continuous
Lamp output	4.9 W
Fuse	Device fuse
Reverse polarity protection	Yes
Emergency light marking	Z 1 ***
Light colour	6500 K
Ambient temperature ta min.	-40 °C
Ambient temperature ta max.	+70 °C
Storage temperature / transport min.	-40 °C
Storage temperature / transport max.	+70 °C
Standards	DIN EN 60598-1, DIN EN 60598-2-22
Installation type	Screws
Switching type	Maintained / non-maintained
Degree of protection (IP)	IP65
Power supply	Plug connection RST 20i2, brown
W x H x D (mm)	161 x 104 x 76
Certificates / Approvals	 

PODIS® LED

LED-Luminaire podis® LED RST 120 V DC 5W



Description	Type	Part No.	Part No.	PU
LED-Luminaire	podis® LED RST 120 V DC 5W STD	83.242.0040.0		1
LED-Luminaire	podis® LED RST 120 V DC 5W EMR		83.242.1040.0	1

TECHNICAL DATA	
Min. nominal voltage	19,2 V DC
Max. nominal voltage	120 V DC
Lamp	LED
Lamp output	5.0 W
Fuse	Device fuse
Reverse polarity protection	Yes
Kennzeichnung Notleuchte	Z 1 *** E
Light colour	6000 K
Light output	typ. 450 lm
Light diffusion	Optic
Ambient temperature ta min.	-40 °C
Ambient temperature ta max.	+50 °C
Storage temperature / transport min.	-40 °C
Storage temperature / transport max.	+70 °C
Standards	DIN EN 60598-1, DIN EN 60598-2-22
Installation type	Screws
Degree of protection (IP)	IP65
Power supply	Plug connection RST16i3, 3-pole, green
W x H x D (mm)	153 x 104 x 76
Certificates / Approvals	

LED-Luminaire podis® LED RST 120 V DC 20W



Description	Type	Part No.	Part No.	PU
LED-Luminaire	podis® LED RST 120 V DC 20W STD	83.242.0240.0		1
LED-Luminaire	podis® LED RST 120 V DC 20W EMR		83.242.1240.0	1

TECHNICAL DATA	
Min. nominal voltage	19,2 V DC
Max. nominal voltage	120 V DC
Lamp	LED
Lamp output	20 W
Fuse	Device fuse
Reverse polarity protection	Yes
Kennzeichnung Notleuchte	Z 1 *** E
Light colour	6000 K
Light output	typ. 1900 lm
Light diffusion (see light diffusion)	Optic
Ambient temperature ta min.	-40 °C
Ambient temperature ta max.	+50 °C
Storage temperature / transport min.	-40 °C
Storage temperature / transport max.	+75 °C
Standards	DIN EN 60598-1, DIN EN 60598-2-22
Installation type	Screws
Degree of protection (IP)	IP65
Power supply	Plug connection RST16i3, 3-pole, green
W x H x D (mm)	340 x 100 x 32
Certificates / Approvals	

PODIS® LED

LED-Luminaire podis® LED RST 120 V DC 20W



Description	Type	Part No.	Part No.	PU
LED-Luminaire	podis® LED RST16 120 V DC 20W STD M	99.804.2135.6		1
LED-Luminaire	podis® LED RST16 120 V DC 20W EMR M		99.805.2135.6	1

TECHNICAL DATA	
Min. nominal voltage	19.2 V DC
Max. nominal voltage	120 V DC
Lamp	LED
Lamp output	20 W
Fuse	Device fuse
Reverse polarity protection	Yes
Emergency light marking	Z 1 *** E
Light colour	6000 K
Light output	typ. 1900 lm
Light diffusion (see light diffusion)	Optic
Ambient temperature ta min.	-40 °C
Ambient temperature ta max.	+50 °C
Storage temperature / transport min.	-40 °C
Storage temperature / transport max.	+75 °C
Standards	DIN EN 60598-1, DIN EN 60598-2-22
Installation type	Magnets
Degree of protection (IP)	IP65
Power supply	Plug connection RST16i3, 3-pole, green
W x H x D (mm)	367 x 129 x 43
Certificates / Approvals	

PODIS® LED

LUMINAIRES FOR THE VOLTAGE RANGE 230 V AC/DC

LED-Luminaire podis® LED RST 90-250 V AC 20W



Description	Type	Part No.	PU
LED-Luminaire	RST 90-250 V AC 20 W	83.241.0130.0	1

TECHNICAL DATA	
Min. nominal voltage	90 V AC
Max. nominal voltage	250 V AC
Lamp	LED
Operation mode	Continuous
Lamp output	20 W
Fuse	Device fuse
Reverse polarity protection	Yes
Emergency light marking	Z 1 ***
Light colour	6500 K
Ambient temperature ta min.	-40 °C
Ambient temperature ta max.	+55 °C
Storage temperature / transport min.	-40 °C
Storage temperature / transport max.	+75 °C
Standards	DIN EN 60598-1, DIN EN 60598-2-22
Installation type	Screws
Switching type	Maintained / non-maintained
Degree of protection (IP)	IP65
Power supply	Plug connection RST20i3, black
W x H x D (mm)	347 x 100 x 83
Certificates / Approvals	

LED-Luminaire podis® LED RST 230 V AC 20W



Description	Type	Part No.	Part No.	PU
LED-Luminaire	podis® LED RST 230 V AC 20W	83.243.0240.0		1
LED-Luminaire	podis® LED RST 230 V AC 20W M		83.243.0246.0	1

TECHNICAL DATA	
Min. nominal voltage	200 V AC
Max. nominal voltage	250 V AC
Lamp	LED
Lamp output	20 W
Fuse	Device fuse
Emergency light marking	Z 1 *** E
Light colour	5700 K
Light output	typ. 2400 lm
Ambient temperature ta min.	-40 °C
Ambient temperature ta max.	+50 °C
Storage temperature / transport min.	-40 °C
Storage temperature / transport max.	+75 °C
Standards	DIN EN 60598-1, DIN EN 60598-2-22
Installation type	Screws Magnets
Degree of protection (IP)	IP65
Power supply	Plug connection RST16i3, 3-pole, black
W x H x D (mm)	340 x 100 x 32 367 x 129 x 43

LED-Luminaire podis® LED RST 70-250 V



Description	Type	Part No.	PU
LED-Luminaire	podis® LED-Luminaire RST 70-250 V AC 5W	83.241.0040.0	1

TECHNICAL DATA	
Min. nominal voltage	70 V AC
Max. nominal voltage	250 V AC
Lamp	LED
Operation mode	Continuous
Lamp output	5W
Fuse	Device fuse
Reverse polarity protection	Yes
Emergency light marking	Z 1 ***
Light colour	6500 K
Ambient temperature ta min.	-40 °C
Ambient temperature ta max.	+55 °C
Storage temperature / transport min.	-40 °C
Storage temperature / transport max.	+75 °C
Standards	DIN EN 60598-1, DIN EN 60598-2-22
Installation type	Screws
Switching type	Maintained / non-maintained
Degree of protection (IP)	IP65
Power supply	Plug connection RST 20i3, black
W x H x D (mm)	161 x 104 x 75,7
Certificates / Approvals	

PODIS® LED

LED-Luminaire podis® LED RST 230 V AC 2 x 3W



Description	Type	Part No.	Part No.	PU
LED-Luminaire	podis® LED RST 230 V AC 2 x 3W	83.243.0040.0		1
LED-Luminaire	podis® LED RST 230 V AC 2 x 3W M		83.243.0046.0	1

TECHNICAL DATA

Min. nominal voltage	200 V AC
Max. nominal voltage	250 V AC
Lamp	LED
Lamp output	2 x 3 W
Fuse	Device fuse
Emergency light marking	Z 1 *** E
Light colour	5000 K
Light output	typ. 300 lm
Ambient temperature ta min.	-40 °C
Ambient temperature ta max.	+50 °C
Storage temperature / transport min.	-40 °C
Storage temperature / transport max.	+75 °C
Standards	DIN EN 60598-1, DIN EN 60598-2-22
Installation type	Screws Magnets
Degree of protection (IP)	IP65
Power supply	RST 20i5, Plug, black
Connection energy outlet	2 x RST 20i5, Female, black
W x H x D (mm)	161 x 104 x 76 180 x 130 x 82

LED-Luminaire podis® LED RST 230 V AC 2 x 3W 1U



Description	Type	Part No.	PU
LED-Luminaire	podis® LED RST 230 V AC 2 x 3W 1U	83.243.0030.0	1

TECHNICAL DATA

Min. nominal voltage	200 V AC
Max. nominal voltage	250 V AC
Lamp	LED
Lamp output	2 x 3 W
Fuse	Device fuse
Emergency light marking	Z 1 *** E
Light colour	5000 K
Light output	typ. 500 lm
Ambient temperature ta min.	-40 °C
Ambient temperature ta max.	+50 °C
Storage temperature / transport min.	-40 °C
Storage temperature / transport max.	+75 °C
Standards	DIN EN 60598-1, DIN EN 60598-2-22
Installation type	Screws
Degree of protection (IP)	IP65
Power supply	RST 20i3, Plug, black
Connection energy outlet	RST 20i3, Female, black
W x H x D (mm)	161 x 104 x 76

ACCESSORIES

The right accessory for every application.

Wieland Electric offers you the right accessory for every application. Whether professional tools, end pieces or adapters are concerned – naturally all accessory parts comply with the prescribed standards. With the decision for Wieland original accessories, you are always right.

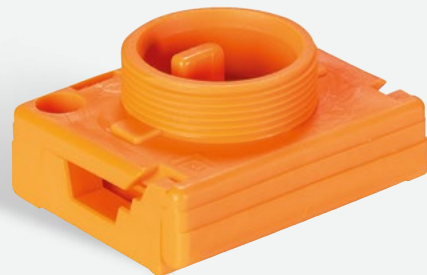
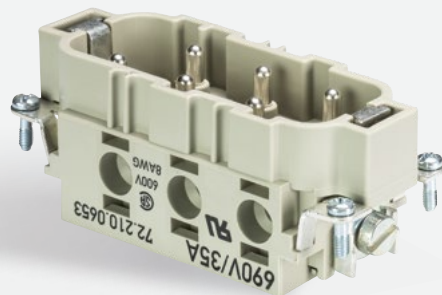

PRODUCTS

- + AS-i accessories
- + Round cable adapter / front side pluggable connector
- + Sample sets
- + Cutter/Stripping pliers/Stripping knife
- + Mounting plates
- + Mounting clip for power bus

ACCESSORIES

Cable gland



Description	Type	Part No.	PU
Cable gland	M20 x 1.5, black	Z5.507.1353.1	1
Cable gland	M20 x 1.5, with AS-i insert, black	Z5.505.0653.1	1
Lock nut	M20 x 1.5, black	05.505.0153.1	1
Cable gland	M25 x 1.5, (for Cable 9-16 mm) black	Z5.507.1453.1	1
Cable gland	M25 x 1.5, (for Cable 13-18 mm) black	Z5.507.1553.1	1
Lock nut	M25 x 1.5, black	05.505.0253.1	1
Cable gland	M32 x 1.5, (for Cable 10-21 mm) black	Z5.507.1753.1	1
Cable gland	M32 x 1.5, (for Cable 18-25 mm) black	Z5.507.1653.1	1
Lock nut	M32 x 1.5, black	05.505.0353.1	1
Multiple feed-through	3 x 8 mm for M25, Z5.507.1553.1	05.512.4883.0	1
Multiple feed-through	4 x 7 mm for M25, Z5.507.1553.1	05.512.5083.0	1
Multiple feed-through	2 x 8 mm for M32, Z5.507.1653.1	05.512.4383.0	1

AS-i branch cable



AS-i branch cable M12 plug straight on socket straight; length 300 mm.

Description	Type	Part No.	PU
AS-i branch cable		83.209.2203.0	1

AS-i pick-off M12



AS-i pick-off M12; can be used as pick-off distributor or plug, re-usable penetration technique acc. to IEC 68 and DIN 41611.

Description	Type	Part No.	PU
AS-i pick-off M12		83.209.2201.0	1

Cable gland M20 x 1.5 with AS-i insert



Cable gland M20 x 1.5 for AS-i profile cable, compatible with 75.010.0053.1 and 75.016.2053.1; black RAL 9005.

Description	Type	Part No.	PU
Cable gland		Z5.505.0653.1	1

ACCESSORIES

ROUND CABLE ADAPTER / FRONT SIDE PLUGGABLE CONNECTOR

Hood FCS GOT 16 GB FLD



Upper housing BAS GOT16 FCS ZH; with podis® tray cable feedthrough, for two-hand locking without locking; degree of protection IP65; color: silver gray RAL 7001.

Description	Type	Part No.	PU
Hood	FCS GOT 16 GB FLD	75.900.1628.0	1

Hood FCS GOT 16 GF FLD



Upper housing BAS GOT16 FCS ZH V; with podis® tray cable feed-through, for two-hand locking; degree of protection IP65; color: silver gray RAL 7001.

Description	Type	Part No.	PU
Hood	FCS GOT 16 GF FLD	75.900.1528.0	1

Female insert POW BUS 6 6,0 69 AG



revosPOWER 6 pole + PE, female insert, 690 V / 35 A screw connection.

Description	Type	Part No.	PU
Female insert	POW BUS 6 6,0 69 AG	72.200.0653.0	1

Male insert POW STS 6 6,0 69 AG

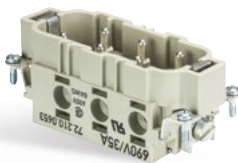

revosPOWER 6 pole + PE, male insert, 690 V / 35 A screw connection.

Description	Type	Part No.	PU
Male insert DIN 3128	POW STS 6 6,0 69 AG	72.210.0653.0	1

ACCESSORIES

SAMPLE SETS

Sample set podis® CON 7G4



Description	Type	Part No.	PU
Sample set podis® CON 7G4		99.780.0000.0	1

Sample set podis® CON 5G6



Description	Type	Part No.	PU
Sample set podis® CON 5G6		99.781.0000.0	1

Sample set podis® CON 5G16



Description	Type	Part No.	PU
Sample set podis® CON 5G16		99.782.0000.0	1

Sample case podis® CON



podis® sample case for the presentation of the podis® power bus system.

Description	Type	Part No.	PU
Sample case podis® CON 5G6	5G6	99.784.0000.0	1
Sample case podis® CON 5G16	5G16	99.785.0000.0	1
Sample case podis® CON 7G4	7G4	99.786.0000.0	1

ACCESSORIES TOOLS

Cutter



Cutter for podis and gesis cables up to 5G16 (AWG 5C6), blade length 40 mm.

Description	Type	Part No.	PU
Cutter	podis®/gesis®	F0.000.0051.9	1

Stripping knife



Dismantling knife for traycable.

Description	Type	Part No.	PU
Stripping knife	podis® CON 5G6	95.350.0800.0	1
Stripping knife	podis® CON 5G16	95.350.1000.0	1
Stripping knife	podis® CON 7G4	95.350.1100.0	1

Screwdriver blade



Screw driver insert PH1 x 70.

Description	Type	Part No.	PU
Screwdriver blade	DIN 3128	06.502.5200.0	1
Screwdriver blade	Torx 15x70	06.502.6410.0	1

Power supply unit



Switching power supply 100-240 V AC; with exchangeable plugs CEE7/4 (Schuko), US, UK, CN; 24 V DC, 1,25 A; RST20i2 brown coding

Description	Type	Part No.	PU
Power supply unit		99.682.0000.0	1

ACCESSORIES

MOUNTING PLATES

Mounting plate for RST®-housing



Mounting plate inside wire tray



Mounting plate for easy installation inside wire tray with grid 50 x 100 mm; secure fastening with no loose parts (screws, nuts, rivets, etc.); stainless steel; 2 pieces needed per luminaire.

Description	Part No.	PU
Mounting plate	05.560.3419.0	1

Applicable to Art.No.: 83.240.0030.0, 83.240.0031.1, 83.241.0040.0, 83.240.0050.0

Mounting plate outside wire tray



Mounting plate for easy installation outside wire tray with grid 50 x 100 mm; secure fastening with no loose parts (screws, nuts, rivets, etc.); stainless steel.

Description	Part No.	PU
Mounting plate	G0.500.2041.5	1

Applicable to Art.No.: 83.240.0030.0, 83.240.0031.1, 83.241.0040.0, 83.240.0050.0

Mounting plate for podis® LED 20 W

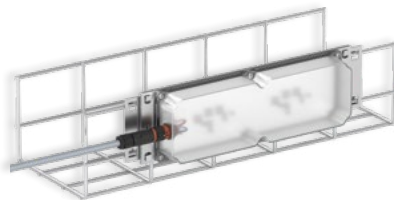

Mounting plate outside wire tray



Mounting plate for easy installation of podis® LED 2klm (20 W) outside wire tray with grid 50 x 100 / 35...40 x 100 mm.

Description	Part No.	PU
Mounting plate	05.560.3319.0	1

Applicable to Art.No.: podis® LED 20 W, 83.24x.x1xx.x, 83.24x.x2xx.x, 99.80x.0220.0

Mounting plate outside wire tray



Mounting plate for easy installation outside wire tray with grid 50 x 100 / 25 x 100 mm; secure fastening with no loose parts (screws, nuts, rivets, etc.); stainless steel.

Description	Part No.	PU
Mounting plate	05.560.4019.0	1

Applicable to Art.No.: podis® LED 20 W, 83.24x.x1xx.x, 83.24x.x2xx.x, 99.80x.0220.0

Similar to illustration

ACCESSORIES

MOUNTING PLATES

Mounting plate for podis® CON 7G4

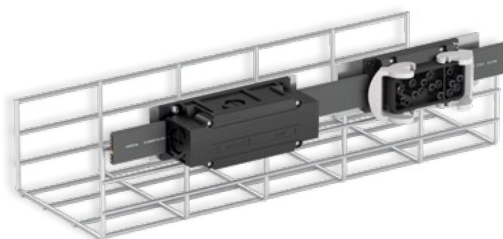

Mounting plate outside wire tray



Similar
to illustration

Mounting plate for easy installation of podis®LED 2klm (20 W) outside wire tray with grid 50 x 100 / 35...40 x 100 mm.

Description	Part No.	PU
Mounting plate	05.560.3619.0	1

Applicable to Art.No.: 75.015.5153.1, 75.018.0051.2

Mounting plate outside wire tray



Mounting plate for easy installation outside wire tray with grid 50 x 100 / 25 x 100 mm; secure fastening with no loose parts (screws, nuts, rivets, etc.); stainless steel.

Description	Part No.	PU
Mounting plate	05.560.4219.0	1

Applicable to Art.No.: 75.015.5153.1, 75.018.0051.2

Mounting plate for podis® CON 7G4

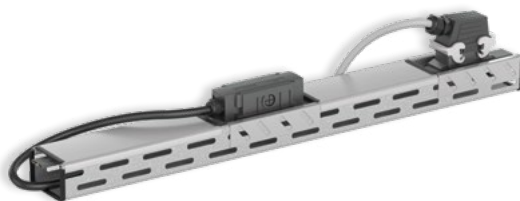

Mounting plate on the cable duct



Mounting plate for easy installation on cable duct with width 100 mm.

Description	Part No.	PU
Mounting plate	05.569.4210.0	1

Applicable to Art.No.: 75.015.5153.1, 75.018.0051.2

ACCESSORIES

CABLE CLIP



Cable clip

Cable clip for flat cable.

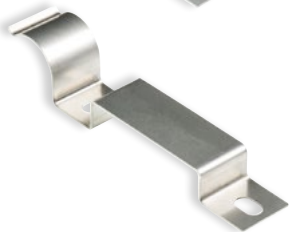
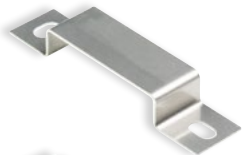

Description	Type	Part No.	PU
Cable clip	podis® CON 7G4, light gray	05.562.3000.0	1
Cable clip	podis® CON 5G16, stainless steel	05.601.2519.0	1
Cable clip	podis® CON 5G16 + installation tube 20 mm, stainless steel	05.601.2419.0	1
Cable clip	podis® CON 5G6/5G16, plastic black	07.432.8100.0	1

RST® AS A SYSTEM SUPPLEMENT

As a complete installation system, RST® provides significant reduction of installation time. The components, fully assembled at the factory, only need to be plugged together in the field – no trimming, stripping or removing insulation.

This substantially reduces operational downtime. In case of defective devices or routine maintenance, loads can rapidly be disconnected from power. Another advantage is the fact that technicians no longer need to open the device for electrical connection. Faulty assembly is thereby eradicated, especially with water-protected devices.

- + Time saving
- + 30 % less costs
- + Industrial prefabricated quality

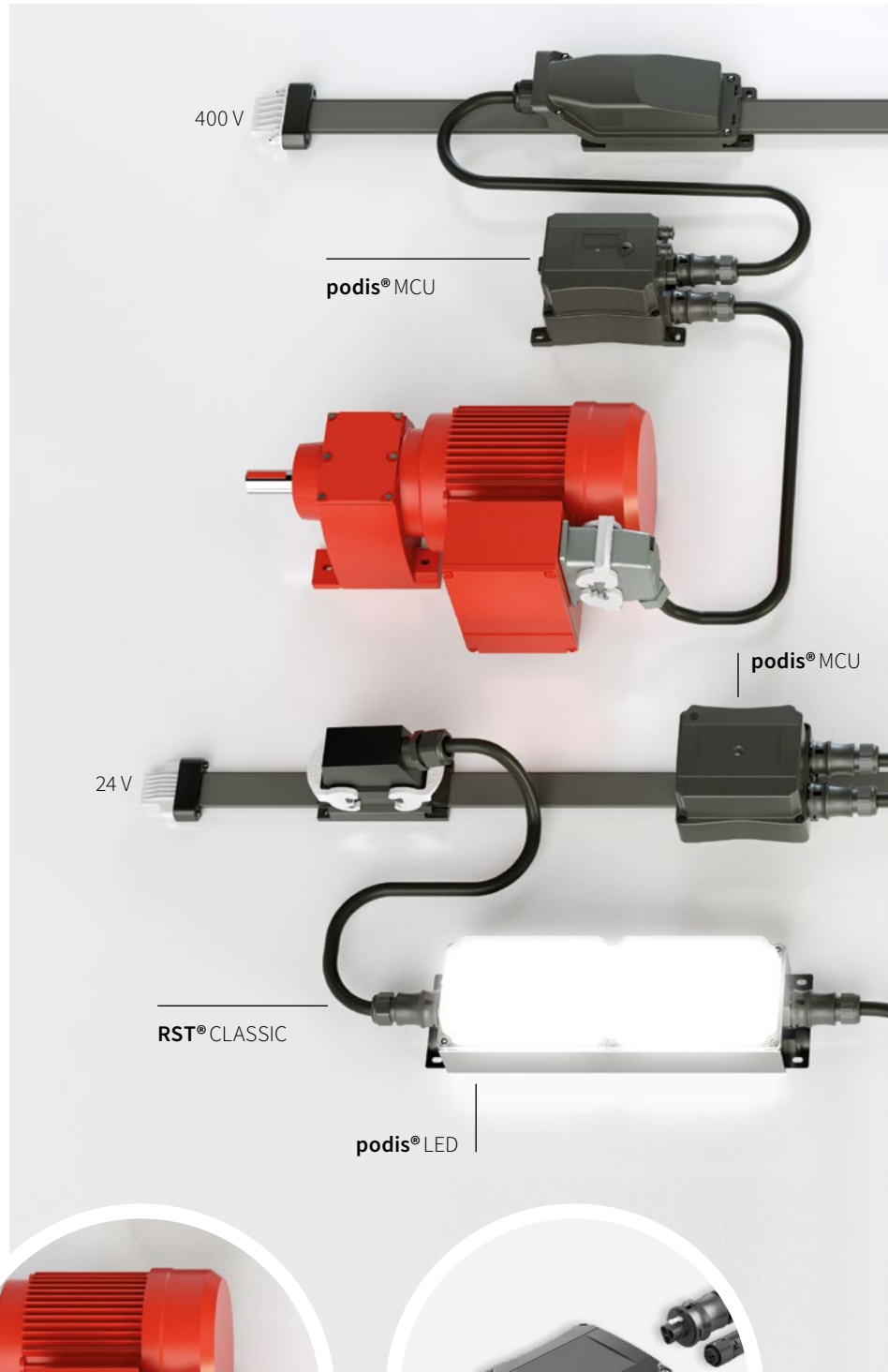

MOTOR CONNECTION (3~)



ENERGY DISTRIBUTION

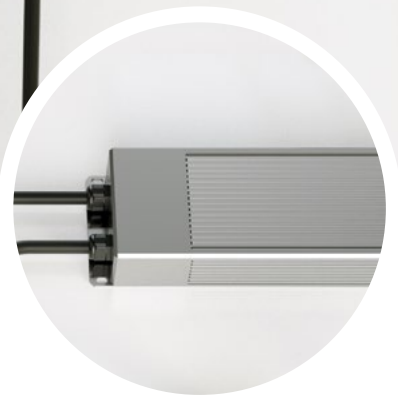
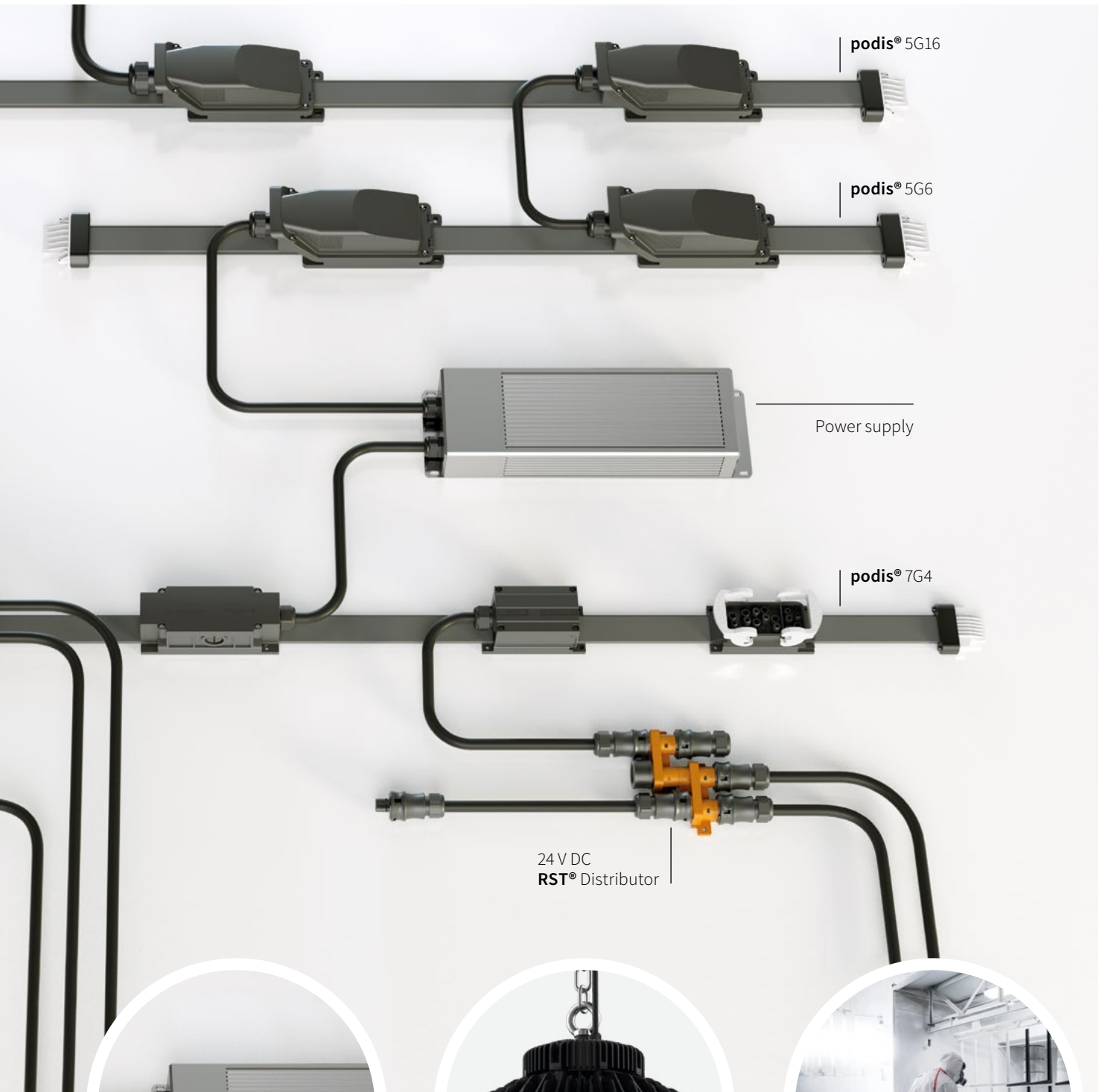

POWER SUPPLY



WORKPLACE LIGHTING



PAINT CONTROLS

RST®

For unlimited options.

The RST® installation system opens up a whole world of new opportunities. Entire system components can be fully pre-assembled and tested, independent of their later destination. The individual modules then only need to be connected to each other on-site.

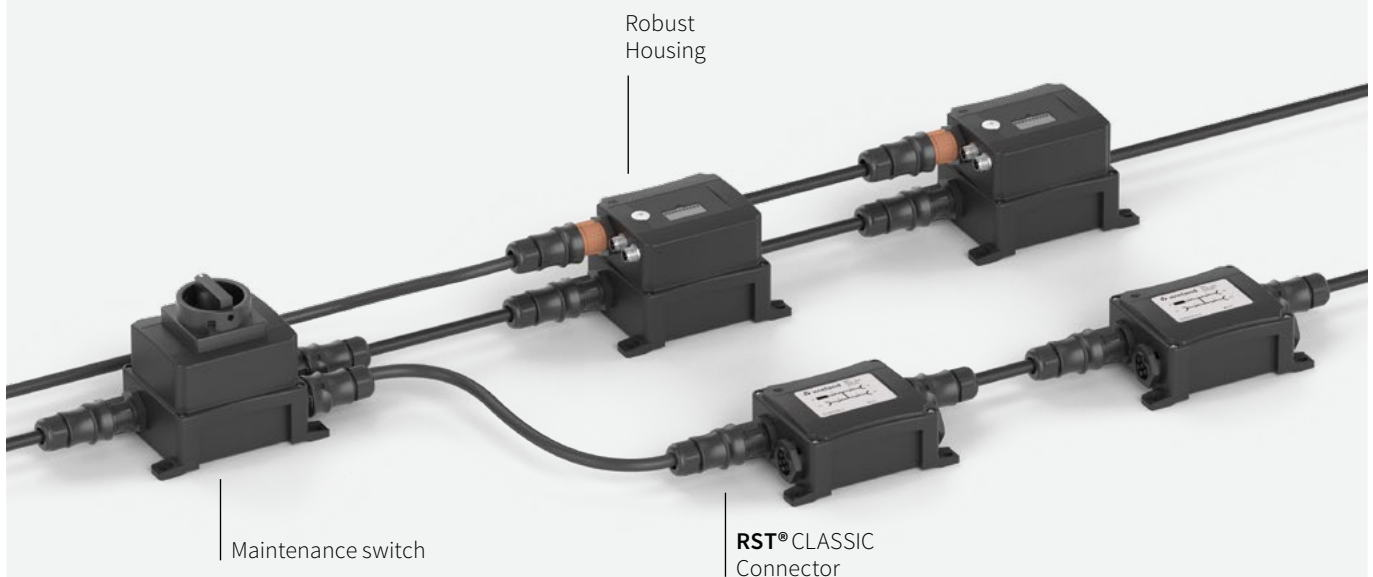

FEATURES

- + Mechanical + Color Coding
- + 3- and 5-pole for power
- + 2- and 4-pole for 24 V or AS-i/ 24 V
- + Device connections are equipped with standard threads (M16 to M25)



RST® – PLUG IN AND GO.

Installation instructions RST®

1
Connect conductor

2
Close ...
Click!
Click!

3
or open ...

4
plug in or lock – ready!

5
Unlock plug connection

TWIST LOCK

BENEFITS:

- Touch-protected
- Neat cable run
- Easy extension or modification
- Reusable
- Mechanically coded
- Integrated locks and strain reliefs
- Degree of protection IP66 / 68 (3m, 2h) / 69
- Type Rating 4X / 6P

RST® PLUGGABLE CONNECTORS

Socket part with strain relief



Pluggable connector RST20i5, 5 pole, screw-in socket part, 250/400 V, 20 A, for cable diameter 6-10 mm, black color coding, black housing color; for rigid, for fine-stranded and multi-stranded cables from 0.75 to 4 mm²; Degree of protection IP66 / 68 (3 m, 2 h) / 69K; unassembled with cable gland and locking.

Description	Type	Part No.	PU
Socket part	RST20i5S B1 ZR1 SW	96.051.4053.1	1
TECHNICAL DATA			
Rated voltage (V)		400 / 600 for UL	
Rated current (A)		20	
Design		Socket	
Connection type		Screw connection	
Number of poles		5	
Cable diameter		6-10 mm	
Certificates / Approvals			

Socket part with strain relief



Pluggable connector RST20i5, 5 pole, screw-in socket part, 250/400 V, 20 A, for cable diameter 10-14 mm, black color coding, black housing color; for rigid, for fine-stranded and multi-stranded cables from 0.75 to 4 mm²; Degree of protection IP66 / 68 (3 m, 2 h) / 69K; unassembled with cable gland and locking.

Description	Type	Part No.	PU
Socket part	RST20i5S B1 ZR2 SW	96.051.4153.1	1
TECHNICAL DATA			
Rated voltage (V)		400 / 600 for UL	
Rated current (A)		20	
Design		Socket	
Connection type		Screw connection	
Number of poles		5	
Cable diameter		10-14 mm	
Certificates / Approvals			

Socket part with strain relief



Pluggable connector RST20i5, 5 pole, screw-in socket part, 250/400 V, 20 A, for cable diameter 13-18 mm, black color coding, black housing color; for rigid, fine-stranded and multi-stranded cables from 0,75 to 4 mm²; Degree of protection IP66 / 68 (3 m, 2 h) / 69K; unassembled with cable gland and locking.



Description	Type	Part No.	PU
Socket part	RST20i5S B1 ZR3 SW	96.051.4553.1	1
TECHNICAL DATA			
Rated voltage (V)		400 / 600 for UL	
Rated current (A)		20	
Design		Socket	
Connection type		Screw connection	
Number of poles		5	
Cable diameter		13-18 mm	
Certificates / Approvals			

RST® PLUGGABLE CONNECTORS

Plug part with strain relief





Pluggable connector RST20i5, 5 pole, screw-in plug part, 250/400 V, 20 A, for cable diameter 10-14 mm, black color coding, black housing color; for rigid, fine-stranded and multi-stranded cables from 0.75 to 4 mm²; Degree of protection IP66 / 68 (3 m, 2 h) / 69K; unassembled with cable gland and locking.

Description	Type	Part No.	PU
Plug part	RST20i5S S1 ZR1 V SW	96.052.4053.1	1
TECHNICAL DATA			
Rated voltage (V)		400 / 600 for UL	
Rated current (A)		20	
Design		Plug	
Connection type		Screw connection	
Number of poles		5	
Cable diameter		6-10 mm	
Certificates / Approvals		  	

Plug part with strain relief





Pluggable connector RST20i5, 5 pole, screw-in plug part, 250/400 V, 20 A, for cable diameter 10-14 mm, black color coding, black housing color; for rigid, fine-stranded and multi-stranded cables from 0.75 to 4 mm²; Degree of protection IP66 / 68 (3 m, 2 h) / 69K; unassembled with cable gland and locking.

Description	Type	Part No.	PU
Plug part	RST20i5S S1 ZR2 V SW	96.052.4153.1	1
TECHNICAL DATA			
Rated voltage (V)		400 / 600 for UL	
Rated current (A)		20	
Design		Plug	
Connection type		Screw connection	
Number of poles		5	
Cable diameter		10-14 mm	
Certificates / Approvals		  	

Plug part with strain relief



Pluggable connector RST20i5, 5 pole, screw-in plug part, 250/400 V, 20 A, for cable diameter 13-18 mm, black color coding, black housing color; for rigid, fine-stranded and multi-stranded cables up to 4 mm²; Degree of protection IP66 / 68 (3 m, 2 h) / 69K; unassembled with cable gland and locking.

Description	Type	Part No.	PU
Plug part	RST20i5S S1 ZR3 V SW	96.052.4553.1	1
TECHNICAL DATA			
Rated voltage (V)		400 / 600 for UL	
Rated current (A)		20	
Design		Plug	
Connection type		Screw connection	
Number of poles		5	
Cable diameter		13-18 mm	
Certificates / Approvals		  	

RST®

PLUGGABLE CONNECTORS / DEVICE CONNECTOR M25

Socket part with strain relief



Pluggable connector RST20i4, 4 pole, screw-in socket part, 50 V, 20 A, for cable diameter 6-10 mm, brown color coding, black housing color; for rigid, for fine-stranded and multi-stranded cables from 0.75 to 4 mm²; unassembled with cable gland and locking.

Description	Type	Part No.	PU
Socket part	RST20i4S B1 ZR1SVL BR01	96.041.4051.4	1

TECHNICAL DATA	
Rated voltage (V)	50
Rated current (A)	20
Design	Socket
Connection type	Screw connection
Number of poles	4
Cable diameter	6-10 mm
Certificates / Approvals	

Socket part with strain relief



Pluggable connector RST20i4, 4 pole, screw-in plug part, 50 V, 20 A, for cable diameter 6-10 mm, brown color coding, black housing color; for rigid, for fine-stranded and multi-stranded cables from 0.75 to 4 mm²; unassembled with cable gland and locking.

Description	Type	Part No.	PU
Plug part	RST20i4S S1 ZR1SVL BR01	96.042.4051.4	1





TECHNICAL DATA	
Rated voltage (V)	50
Rated current (A)	20
Design	Plug
Connection type	Screw connection
Number of poles	4
Cable diameter	6-10 mm
Certificates / Approvals	

Socket part with strain relief



Connector RST25i5, 5-pole, screw technology female connector, 250 V / 25 A, for cable diameter 10-14 mm, coding color concrete gray, housing color black.

Description	Type	Part No.	PU
Socket part	RST25i5S B1 ZR2S BG0	96.051.4154.3	1

TECHNICAL DATA	
Rated voltage (V)	250
Rated current (A)	25
Design	Socket
Connection type	Screw connection
Number of poles	5
Cable diameter	10-14 mm
Certificates / Approvals	    

RST®

PLUGGABLE CONNECTORS / DEVICE CONNECTOR M25

Plug part with strain relief



Connector RST25i5, 5-pole, screw technology male connector, 250 V / 25 A, for cable diameter 10-14 mm, coding color concrete gray, housing color black.

Description	Type	Part No.	PU
Plug part	RST25i5S S1 ZR2SV BG0	96.052.4154.3	1

TECHNICAL DATA	
Rated voltage (V)	250
Rated current (A)	25
Design	Plug
Connection type	Screw connection
Number of poles	5
Cable diameter	10-14 mm
Certificates / Approvals	

Socket part, sealable



Device connector, standard M25, RST25i5, 5-pole, screw technology female connector, 250 / 400 V, 25 A, coding color concrete gray, nut color black.

Description	Type	Part No.	PU
Female connector	RST25i5S B1 M01V GR0	96.051.5054.3	1

TECHNICAL DATA	
Rated voltage (V)	250
Rated current (A)	25
Design	Socket
Connection type	Screw connection
Number of poles	5
Thread for housing feed-through	M25
Certificates / Approvals	

Plug part, sealable



Device connector, standard M25, RST25i5, 5-pole, screw technology male connector, 250 / 400 V, 25 A, coding color concrete gray, nut color black.

Description	Type	Part No.	PU
Male connector	RST25i5S S1 M01V BG0	96.052.5054.3	1

TECHNICAL DATA	
Rated voltage (V)	250
Rated current (A)	25
Design	Plug
Connection type	Screw connection
Number of poles	5
Thread for housing feed-through	M25
Certificates / Approvals	

RST®

For the AS Interface.



Distributor blocks allow for distribution of electrical power and signals within the network. Assembled cables are available in different lengths and designs, and are used for forwarding and feeding of auxiliary power/signals. Device connections are integrated directly into the end device and represent the interface to the pluggable connector system.

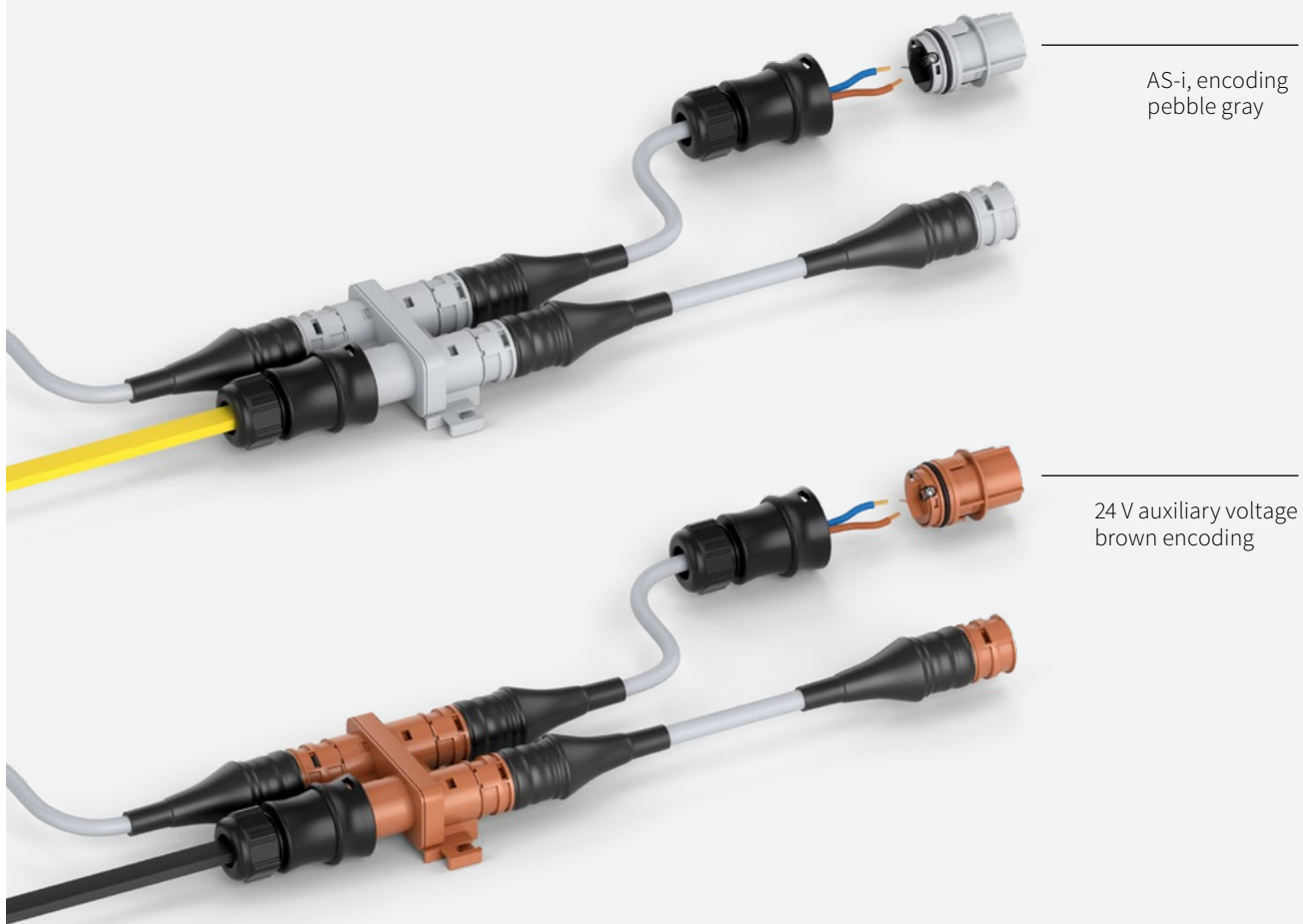

AS-i, encoding
pebble gray

24 V auxiliary voltage
brown encoding

FEATURES

- + 50 V, 20 A
- + IP66 / IP68 (3 m; 2 h) / 69
- + Temperatures of -40 to +100° C
- + Screw connection 0.5 – 4.0 mm²



THE QUICK MOUNTING SYSTEM

As a complete installation system, RST® provides a clear reduction of installation time. The components, fully assembled at the factory, only need to be plugged together in the field. No more tedious trimming, stripping, insulation removal and connecting.



MECHANICAL + COLOR CODING

Each circuit has its own mechanical encoding. Mechanical encoding means that only matching plug-and-socket pairs can be plugged together. This ensures the clear separation of the two circuits.



PLUGGABLE CONNECTORS CAN BE ASSEMBLED ON-SITE

Complex system components can be fully pre-assembled and tested, independent of their later destination. The individual modules then only need to be connected to each other on-site. Pluggable connectors can be assembled on-site and are available optionally for connection of a round cable or the AS-i profile cable.



RST®

ASSEMBLED CABLES

Interconnecting cable Plug – Socket



Round pluggable connector, assembled with cable “Ölflex Classic 110 5G2.5”, socket on one side / plug on the other, cable cross-section: 2.5 mm², color: Pluggable connector black, cable gray, system: RST20/5KS BS 250 10SW total length: 1000 mm.

Description	Type	Part No.	PU
Assembled cable	RST20i5KSBS 250 10SW	96.453.1080.1	1

TECHNICAL DATA	
Rated voltage (V)	400
Rated current (A)	20
Number of poles	5
Cable cross-section (mm ²)	2,5
Design side 1	Plug
Design side 2	Socket
Cable end treatment	-
Cable type	Ölflex Classic 110 5G2.5
Cable diameter (mm)	10
Stripping length (mm)	-
Wire strip length (mm)	-
Cable length (m)	1.0
Certificates / Approvals	

Versions	Type	Part No.	PU	
Cable length (m)	2.0	RST20i5KSBS 250 20SW	96.453.2080.1	1
	3.0	RST20i5KSBS 250 30SW	96.453.3080.1	1
	4.0	RST20i5KSBS 250 40SW	96.453.4080.1	1
	5.0	RST20i5KSBS 250 50SW	96.453.5080.1	1
	6.0	RST20i5KSBS 250 60SW	96.453.6080.1	1
	7.0	RST20i5KSBS 250 70SW	96.453.7080.1	1
	8.0	RST20i5KSBS 250 80SW	96.453.8080.1	1
	9.0	RST20i5KSBS 250 90SW	96.453.9080.1	1

Connection cable Socket – open end



Round pluggable connector, assembled with cable “Ölflex Classic 110 5G2.5”, socket on one side / free end on the other, cable cross-section: 2.5 mm², color: Pluggable connector black, cable gray, system: RST20/5KS B- 250 10SW, total length: 1000 mm.

Description	Type	Part No.	PU
Assembled cable	RST20i5KSB- 250 10SW	96.453.1083.1	1

TECHNICAL DATA	
Rated voltage (V)	400
Rated current (A)	20
Number of poles	5
Cable cross-section (mm ²)	2.5
Design side 1	Socket
Design side 2	Open end
Cable end treatment	ultrasonically compressed wire ends
Cable type	Ölflex Classic 110 5G2.5
Cable diameter (mm)	10
Stripping length (mm)	35
Wire strip length (mm)	9
Cable length (m)	1.0
Certificates / Approvals	-

Versions	Type	Part No.	PU	
Cable length (m)	2.0	RST20i5KSB- 250 20SW	96.453.2083.1	1
	3.0	RST20i5KSB- 250 30SW	96.453.3083.1	1
	4.0	RST20i5KSB- 250 40SW	96.453.4083.1	1
	5.0	RST20i5KSB- 250 50SW	96.453.5083.1	1
	6.0	RST20i5KSB- 250 60SW	96.453.6083.1	1
	7.0	RST20i5KSB- 250 70SW	96.453.7083.1	1
	8.0	RST20i5KSB- 250 80SW	96.453.8083.1	1
	9.0	RST20i5KSB- 250 90SW	96.453.9083.1	1

RST®

ASSEMBLED CABLES

Connection cable

Plug – open end



Round pluggable connector, assembled with cable "Ölflex Classic 110 5G2.5", plug on one side / free end on the other, cable cross-section: 2.5 mm², color: Pluggable connector black, cable gray, system: RST20i5KS-S 250 10SW, total length: 1000 mm.

Description	Type	Part No.	PU
Assembled cable	RST20i5KS-S 250 10SW	96.453.1084.1	1

TECHNICAL DATA	
Rated voltage (V)	400
Rated current (A)	20
Number of poles	5
Cable cross-section (mm ²)	2.5
Design side 1	Plug
Design side 2	Open end
Cable end treatment	ultrasonically compressed wire ends
Cable type	Ölflex Classic 110 5G2.5
Cable diameter (mm)	10
Stripping length (mm)	35
Wire strip length (mm)	9
Cable length (m)	1.0
Certificates / Approvals	-

Versions	Type	Part No.	PU	
Cable length (m)	2.0	RST20i5KS-S 250 20SW	96.453.2084.1	1
	3.0	RST20i5KS-S 250 30SW	96.453.3084.1	1
	4.0	RST20i5KS-S 250 40SW	96.453.4084.1	1
	5.0	RST20i5KS-S 250 50SW	96.453.5084.1	1
	6.0	RST20i5KS-S 250 60SW	96.453.6084.1	1
	7.0	RST20i5KS-S 250 70SW	96.453.7084.1	1
	8.0	RST20i5KS-S 250 80SW	96.453.8084.1	1
	9.0	RST20i5KS-S 250 90SW	96.453.9084.1	1

Interconnecting cable

Plug – Socket
for AS-i / 24 V



Round pluggable connector, assembled with cable PVC 4 x 2.5, brown, socket on one side / plug on the other, cable cross-section: 2.5 mm², color: Pluggable connector brown, cable brown, system: RST20i4KSBS 25OL 10BR01, total length: 1000 mm.

Description	Type	Part No.	PU
Assembled cable	RST20i4KSBS 25OL 10BR01	96.443.1082.4	1

TECHNICAL DATA	
Rated voltage (V)	400
Rated current (A)	20
Number of poles	5
Cable cross-section (mm ²)	2.5
Design side 1	Plug
Design side 2	Open end
Cable end treatment	ultrasonically compressed wire ends
Cable type	Ölflex Classic 110 5G2.5
Cable diameter (mm)	10
Stripping length (mm)	35
Wire strip length (mm)	9
Cable length (m)	1.0
Certificates / Approvals	-

Versions	Type	Part No.	PU	
Cable length (m)	2.0	RST20i4KSBS 25OL 20BR01	96.443.2082.4	1
	3.0	RST20i4KSBS 25OL 30BR01	96.443.3082.4	1
	4.0	RST20i4KSBS 25OL 40BR01	96.443.4082.4	1
	5.0	RST20i4KSBS 25OL 50BR01	96.443.5082.4	1
	6.0	RST20i4KSBS 25OL 60BR01	96.443.6082.4	1
	7.0	RST20i4KSBS 25OL 70BR01	96.443.7082.4	1
	8.0	RST20i4KSBS 25OL 80BR01	96.443.8082.4	1
	9.0	RST20i4KSBS 25OL 90BR01	96.443.9082.4	1

RST®

ASSEMBLED CABLES

Connection cable

Socket – open end
for AS-i / 24 V

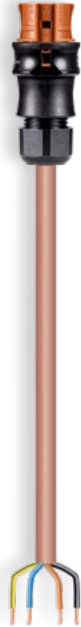

Round pluggable connector, assembled with cable PVC 4 x 2.5, brown, socket on one side / free end on the other, cable cross-section: 2.5 mm², color: Pluggable connector brown, cable brown, system: RST20i4KSB- 25OL 10BR01, total length: 1000 mm.

Description	Type	Part No.	PU
Assembled cable	RST20i4KSB- 25OL 10BR01	96.443.1087.4	1

TECHNICAL DATA			
Rated voltage (V)		50	
Rated current (A)		20	
Number of poles		4	
Cable cross-section (mm ²)		2.5	
Design side 1		Socket	
Design side 2		Open end	
Cable end treatment		ultrasonically compressed wire ends	
Cable type		PVC 4x2.5	
Cable diameter (mm)		9	
Stripping length (mm)		35	
Wire strip length (mm)		9	
Cable length (m)		1.0	
Certificates / Approvals		-	

Versions	Type	Part No.	PU	
Cable length (m)	2.0	RST20i4KSB- 25OL 20BR01	96.443.2087.4	1
	3.0	RST20i4KSB- 25OL 30BR01	96.443.3087.4	1
	4.0	RST20i4KSB- 25OL 40BR01	96.443.4087.4	1
	5.0	RST20i4KSB- 25OL 50BR01	96.443.5087.4	1
	6.0	RST20i4KSB- 25OL 60BR01	96.443.6087.4	1
	7.0	RST20i4KSB- 25OL 70BR01	96.443.7087.4	1
	8.0	RST20i4KSB- 25OL 80BR01	96.443.8087.4	1
	9.0	RST20i4KSB- 25OL 90BR01	96.443.9087.4	1

Connection cable

Plug – open end
for AS-i / 24 V



Round pluggable connector, assembled with cable PVC 4 x 2.5, brown, plug on one side / free end on the other, cable cross-section: 2.5 mm², color: Pluggable connector brown, cable brown, system: RST20i4KS-S 25OL 10BR01, total length: 1000 mm.

Description	Type	Part No.	PU
Assembled cable	RST20i4KS-S 25OL 10BR01	96.443.1088.4	1

TECHNICAL DATA			
Rated voltage (V)		50	
Rated current (A)		20	
Number of poles		4	
Cable cross-section (mm ²)		2.5	
Design side 1		Plug	
Design side 2		Open end	
Cable end treatment		ultrasonically compressed wire ends	
Cable type		PVC 4x2.5	
Cable diameter (mm)		9	
Stripping length (mm)		35	
Wire strip length (mm)		9	
Cable length (m)		1.0	
Certificates / Approvals		-	

Versions	Type	Part No.	PU	
Cable length (m)	2.0	RST20i4KS-S 25OL 20BR01	96.443.2088.4	1
	3.0	RST20i4KS-S 25OL 30BR01	96.443.3088.4	1
	4.0	RST20i4KS-S 25OL 40BR01	96.443.4088.4	1
	5.0	RST20i4KS-S 25OL 50BR01	96.443.5088.4	1
	6.0	RST20i4KS-S 25OL 60BR01	96.443.6088.4	1
	7.0	RST20i4KS-S 25OL 70BR01	96.443.7088.4	1
	8.0	RST20i4KS-S 25OL 80BR01	96.443.8088.4	1
	9.0	RST20i4KS-S 25OL 90BR01	96.443.9088.4	1

RST® DISTRIBUTOR

Distributor box Power

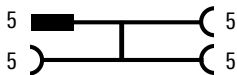

RST® compact distributor RST20i5, 5 pole, 1 input, 3 outputs, with fixing option, 250/400 V, 20 A, black color coding.

Description	Type	Part No.	PU
Distributor box	RST20i5B 3P1 F VG SW	96.050.0153.1	1

TECHNICAL DATA	
Rated voltage (V)	400
Rated voltage Auxiliary power (V)	-
Rated current (A)	20
Number of poles	5
Connection type 1	Plug connection
Connection type 2	Plug connection
Color	black
Degree of protection	IP65, IP66, IP67, IP68 (3 m; 2 h)
Length (mm)	162
Width (mm)	104
Height (mm)	57.2
Certificates / Approvals	-

Distributor box AS-i / 24 V

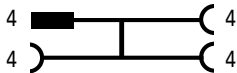

RST® compact distributor RST20i4, 4 pole, 1 input, 3 outputs, with fixing option, AS-i/24 V, 20 A, brown color coding.

Description	Type	Part No.	PU
Distributor box	RST20i4B 3P1 F VGL SW01	96.040.0151.4	1

TECHNICAL DATA	
Rated voltage (V)	-
Rated voltage Auxiliary power (V)	24
Rated current (A)	20
Number of poles	4
Connection type 1	Plug connection
Connection type 2	Plug connection
Color	black
Degree of protection	IP65
Length (mm)	162
Width (mm)	104
Height (mm)	57.2
Certificates / Approvals	-

Distributor box Power AS-i / 24 V

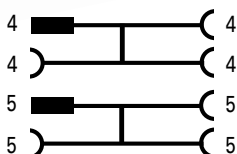







RST® compact distributor RST20i4, 4 pole, 1 input, 3 outputs, AS-i/ 24 V 20 A, brown color coding RST20i5, 5 pole, 1 input, 3 outputs, 250 / 400 V, 20 A, black color coding with fixing option.









Description	Type	Part No.	PU
Distributor box	RST20i5B 4P2 F VGX SW99	99.903.0000.7	1

TECHNICAL DATA	
Rated voltage (V)	400
Rated voltage Auxiliary power (V)	24
Rated current (A)	20
Number of poles	5 and 4
Connection type 1	Plug connection
Connection type 2	Plug connection
Color	black
Degree of protection	IP65
Length (mm)	162
Width (mm)	104
Height (mm)	96
Certificates / Approvals	-

PLUGGABLE CONNECTOR SYSTEMS IN IP66 / 68 (3 M; 2 H) / 69

24 V auxiliary voltage, 2 pole, brown encoding

Pluggable connector for round cables		M25 system connection for housing installation	Assembled cables 2 x 1.5 mm ²		
With screw connection Design: For cables 6-10 mm	Screw connection	Extension cable Socket – Plug Ölflex Classic 100	Connection cable Socket – open end with ultrasonically compressed wire ends Ölflex Classic 100	Connection cable Plug – open end with ultrasonically compressed wire ends Ölflex Classic 100	
Socket part 	Socket part 				
Part No. 96.021.4051.4	Part No. 96.021.5051.4				
Plug part 	Plug part 	Part No. 96.222.x092.4	Part No. 96.222.x097.4	Part No. 96.222.x098.4	
Part No. 96.022.4051.4	Part No. 96.022.5051.4				

Pluggable connector for AS-i profile cable		Distributor 1E/3A	Assembled cables 2 x 2.5 mm ²		
With screw connection, seal, and strain relief, for AS-i profile cable	With fixing option	Extension cable Socket – Plug Ölflex Classic 100	Connection cable Socket – open end with ultrasonically compressed wire ends Ölflex Classic 100	Connection cable Plug – open end with ultrasonically compressed wire ends Ölflex Classic 100	
Socket part 					
Part No. 96.021.4951.4	Part No. 96.020.0151.4				
Plug part 	Caps suitable for any encoding  With loss-protection for socket parts not in use  With loss-protection for plug parts not in use	Part No. 96.223.x092.4	Part No. 96.223.x097.4	Part No. 96.223.x098.4	
Part No. 96.022.4951.4	Part No. 99.414.6205.2	Part No. 99.416.6205.2			









x = cable length in meters (1 to 8 m)

RST®

PLUGGABLE CONNECTOR SYSTEMS IN IP66 / 68 (3 M; 2 H) / 69

AS-i pluggable connector system, 2 pole, pebble gray encoding

Pluggable connector for round cables	M25 system connection for housing installation	Assembled cables 2 x 1.5 mm ²		
Mit Screw connection Design: For cables 6-10 mm	Screw connection	Extension cable Socket – Plug Ölflex Classic 100	Connection cable Socket – open end with ultrasonically compressed wire ends Ölflex Classic 100	Connection cable Plug – open end with ultrasonically compressed wire ends Ölflex Classic 100
Socket part 	Socket part 			
Part No. 96.021.4050.8	Part No. 96.021.5050.8			
Plug part 	Plug part 	Part No. 96.222.x092.8	Part No. 96.222.x097.8	Part No. 96.222.x098.8
Part No. 96.022.4050.8	Part No. 96.022.5050.8			

Pluggable connector for AS-i profile cable	Distributor 1E/3A	Assembled cables 2 x 2.5 mm ²		
Mit Screw connection	With fixing option	Extension cable Socket – Plug Ölflex Classic 100	Connection cable Socket – open end with ultrasonically compressed wire ends Ölflex Classic 100	Connection cable Plug – open end with ultrasonically compressed wire ends Ölflex Classic 100
Socket part 				
Part No. 96.021.4950.8	Part No. 96.020.0150.8			
Plug part 	Caps suitable for any encoding  for socket parts not in use  for plug parts not in use	Part No. 96.223.x092.8	Part No. 96.223.x097.8	Part No. 96.223.x098.8
Part No. 96.022.4950.8	Part No. Z5.564.4553.1	Part No. 05.564.4453.1		

x = cable length in meters (1 to 8 m)

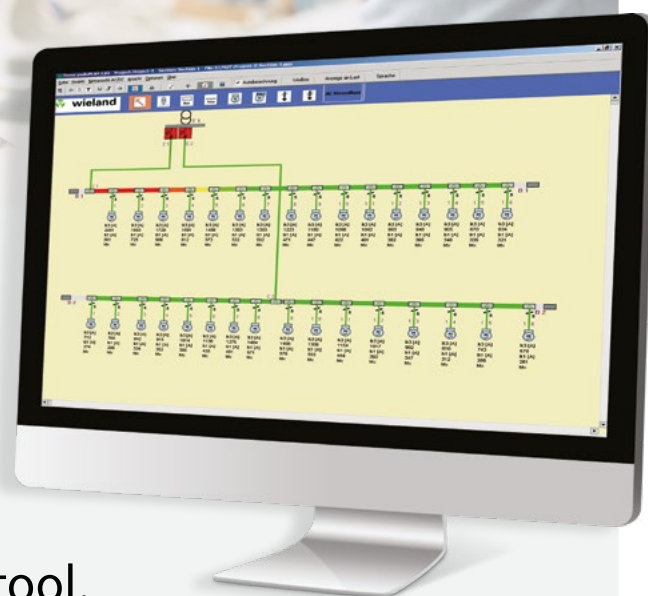

PODIS® PLAN

The efficient project planning tool.

The podis® PLAN project planning tool supports you in calculating the power requirements of your specific power bus configuration. Using graphic support, you can determine the optimum configuration of your power bus with the ideal entry point and prevent down times caused by unresponsive protective devices. Inconsistencies or unfavorable configurations are already detectable in the project planning phase. Costly mistakes are already avoided in the first stage of project planning.

FEATURES

- + Results are provided in diagram or table form
- + Overload and faults are color-highlighted in the diagram
- + For documentation, calculation results can either be stored using the project explorer, or printed out



INFO TO GO

All brochures from Wieland Electric are available for download on our website.



<https://www.wieland-electric.com/en/support/downloads>

Interesting for you

podis® MS 5HP

Motor starter
Conveying - easier than ever
Part No. 0838.1



podis® HELLO CHARGING

The system for supplying electricity to EV charging stations
Part No. 0837.1



RST® Catalog

Efficient installation - pluggable electrical installation systems in highest IP rating
Part No. 0690.1



Wieland on YouTube
See our solutions in motion

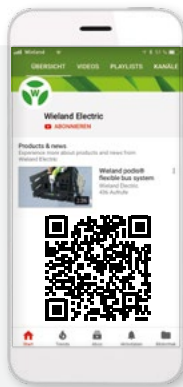

<https://www.youtube.com/user/WielandElectric>



Technical consultation
Building Solutions

Email: industry@wieland-electric.com

Worldwide: <https://wie.li/contactinternational>



ONLY ONE TAP AWAY

Our Wieland E-Shop

Over 25,000 products - anytime

In our online store you will find all the information about our products, prices, and technical data.

Order easily and conveniently online, and check availability.

<https://eshop.wieland-electric.com>

Scan QR code – view products in the E-SHOP.





wieland

HEADQUARTERS

Wieland Electric GmbH
Brennerstraße 10 – 14
96052 Bamberg · Germany

Phone +49 951 9324-0
Fax +49 951 9324-198
info@wieland-electric.com



0830.1 K 09/21

Represented in over 70 countries worldwide:

www.wieland-electric.com