

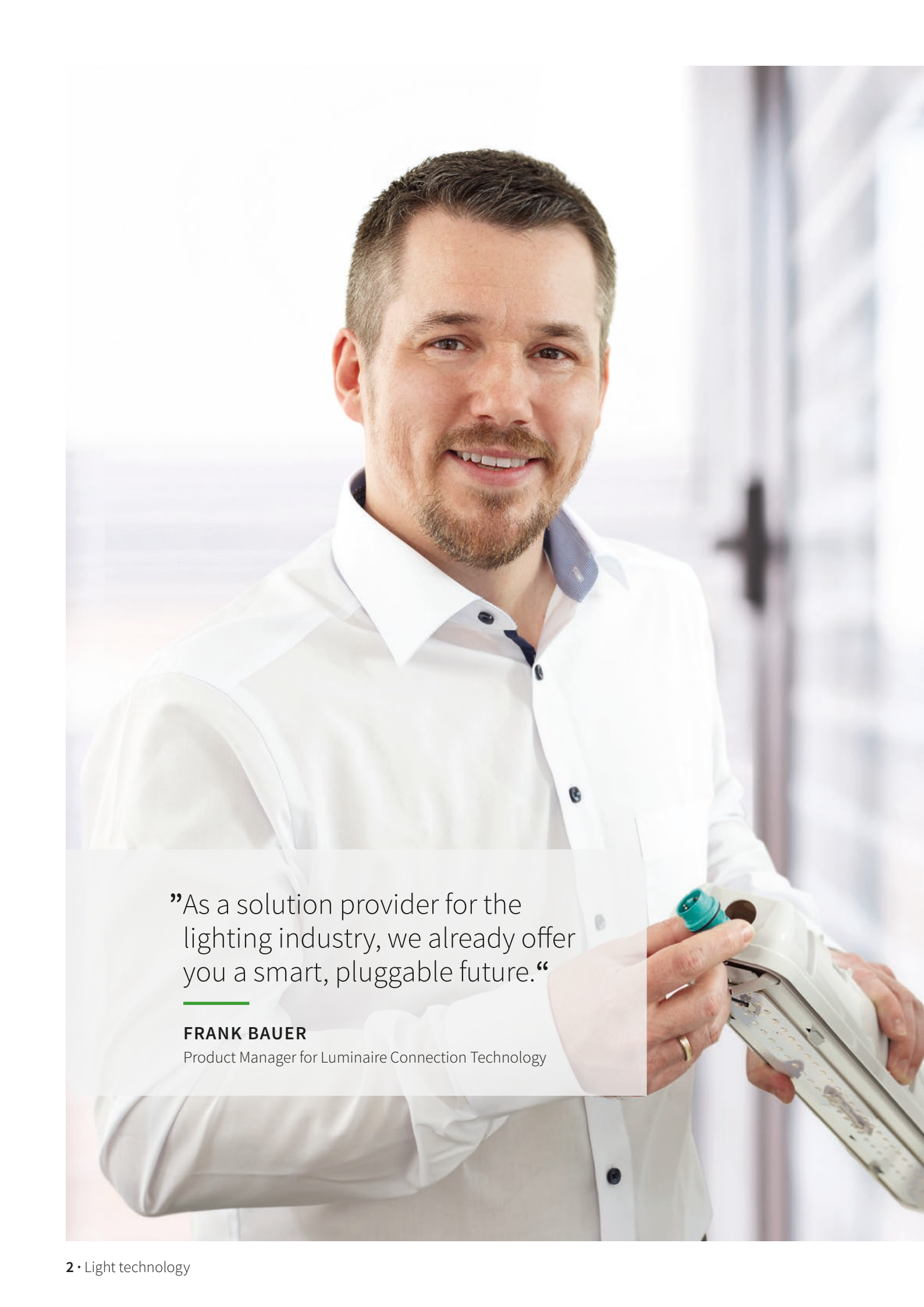

LIGHT TECHNOLOGY

HELLO LIGHT

Solutions for the electrical
connections of luminaires.

A man with a goatee and short brown hair, wearing a white button-down shirt, is smiling and looking towards the camera. He is holding a white, rectangular light fixture component in his left hand and a small green plastic cap in his right hand. The background is a bright, out-of-focus indoor setting, possibly an office or a modern building interior.

”As a solution provider for the lighting industry, we already offer you a smart, pluggable future.“

FRANK BAUER

Product Manager for Luminaire Connection Technology

HELLO LIGHT

- 04** Overview of light technology
- 08** The **gesis**[®] system
- 10** The **RST**[®] system
- 12** System advantages
- 12** Recessed + Panel luminaires
- 14** Downlights + spotlights + drivers
- 16** Under-shelf luminaires + pendant luminaires + lighting systems
- 18** Industrial luminaires
- 20** Street lights + outdoor luminaires
- 22** Architectural + event + garden lighting
- 24** **gesis**[®] system components at a glance
- 26** Printed circuit board terminals for LED application
- 27** **gesis**[®]PLAN + IP protection ratings
- 28** Technical standards + notes
- 29** Our services + offers
- 30** References
- 31** Technical consultation

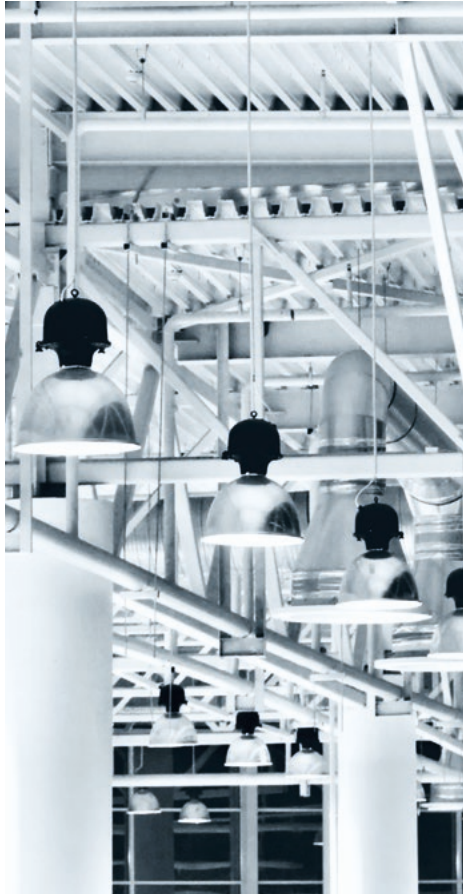

SMART SOLUTIONS FOR LIGHTING TECHNOLOGY.

Wieland is your experienced and reliable partner for efficient + pluggable solutions for connecting indoor and outdoor luminaires. For over 40 years, with our connector systems we have been offering smart products and customized concepts for light technology and consistently improving them.

At the heart of our modular system lie our gesis® and RST® pluggable connectors and device connectors, supplemented by distribution elements, cable assemblies, and accessories. Thanks to standardized interfaces you can create perfectly modular luminaires and lighting concepts and also reduce the effort involved in the initial installation significantly with plug & play.

Subsequent extensions, changes, and replacements of individual components or even entire luminaires can easily be achieved at any time.



MODULAR SYSTEM

All our system components are tailored to your requirements as a luminaire manufacturer.



SAVINGS

Significantly reduced inventory, quick response time for variants, and simplified assembly due to pluggable interfaces.



LEAN PRODUCTION

You make production gains thanks to prefabricated components and optimized tool-free connection technology.

LIGHTING FOR:

- + OFFICES
- + RETAIL
- + HOTELS
- + HOSPITALS
- + FUNCTIONAL BUILDINGS
- + INDUSTRIAL AREAS
- + PARKING GARAGES
- + STREETS
- + OUTDOOR FACILITIES
- + ARCHITECTURE
- + GARDENS
- + EVENTS

SMART **ADVANTAGES** FOR YOUR AREAS OF APPLICATION:

Our system components offer additional advantages, enabling you to win new projects and impress your customers:



SUPERIOR HANDLING

Our industrially prefabricated and tested components are easy to plug together on site. With pluggable gesis® luminaires, your customers save **70 %** of time and up to **30 %** of installation costs.



INVENTORY ADVANTAGES

A positive side-effect of our standardized module production interface is a clear reduction in inventory. At the same time, pre-assemblies improve your response time for variants or special solutions.



SAFE INSTALLATION

Our gesis® and RST® components are secured against unintentional disconnection, touch-proof, and distinguished with international approvals, and also certified quality and safety. The color and mechanical coding prevents mismatching.





FLEXIBLE + FUTURE-PROOF

Our long-standing experience as a market leader and our product quality ensure high contact reliability, a long service life, and high availability. With the simple, pluggable installation your customers are optimally prepared for future modifications and extensions. Compliance with stringent environmental standards in the manufacture and reusability of all components will play a huge part in helping to achieve their environmental objectives.



MODULAR SYSTEM

Through our standardized gesis® interface we offer a modular system for all the electrical connections of your lighting solutions. Whether for indoor luminaires or outdoor luminaires, DALI applications, LED applications, integrated or external ballasts, 2, 3, 4, 5, or 6-pole connections – with gesis® and RST® you are always using the right products.



QUICKER LUMINAIRE ASSEMBLY

Our well-conceived interfaces, the diversified connection technology, and prefabricated cable sets ensure that luminaire assembly is made much simpler by pluggable modules.

APPLICATION FIELDS IN WHICH OUR PRODUCTS AND SOLUTIONS ARE USED.



Recessed luminaires



Downlights



Pendant luminaires



Under-shelf luminaires



Connection between driver + luminaire



Street lights



Highbay luminaires



Damp-proof luminaires



Decorative outdoor luminaires

GESIS® SMART EFFICIENT INDOOR

WIELAND is the inventor of pluggable electrical installation. More than 40 years of experience, know-how, and innovation have gone into our products.

gesis® is the most established cohesive system on the market for efficient, pluggable installation indoor and is constantly being enhanced by our engineers. We continually present products that incorporate the very latest developments and standards in electrical installation and lighting technology.

The large number of high-performance products and components in the gesis® system offer maximum flexibility and feasibility. They can handle all your everyday practical requirements both simple and intelligently.

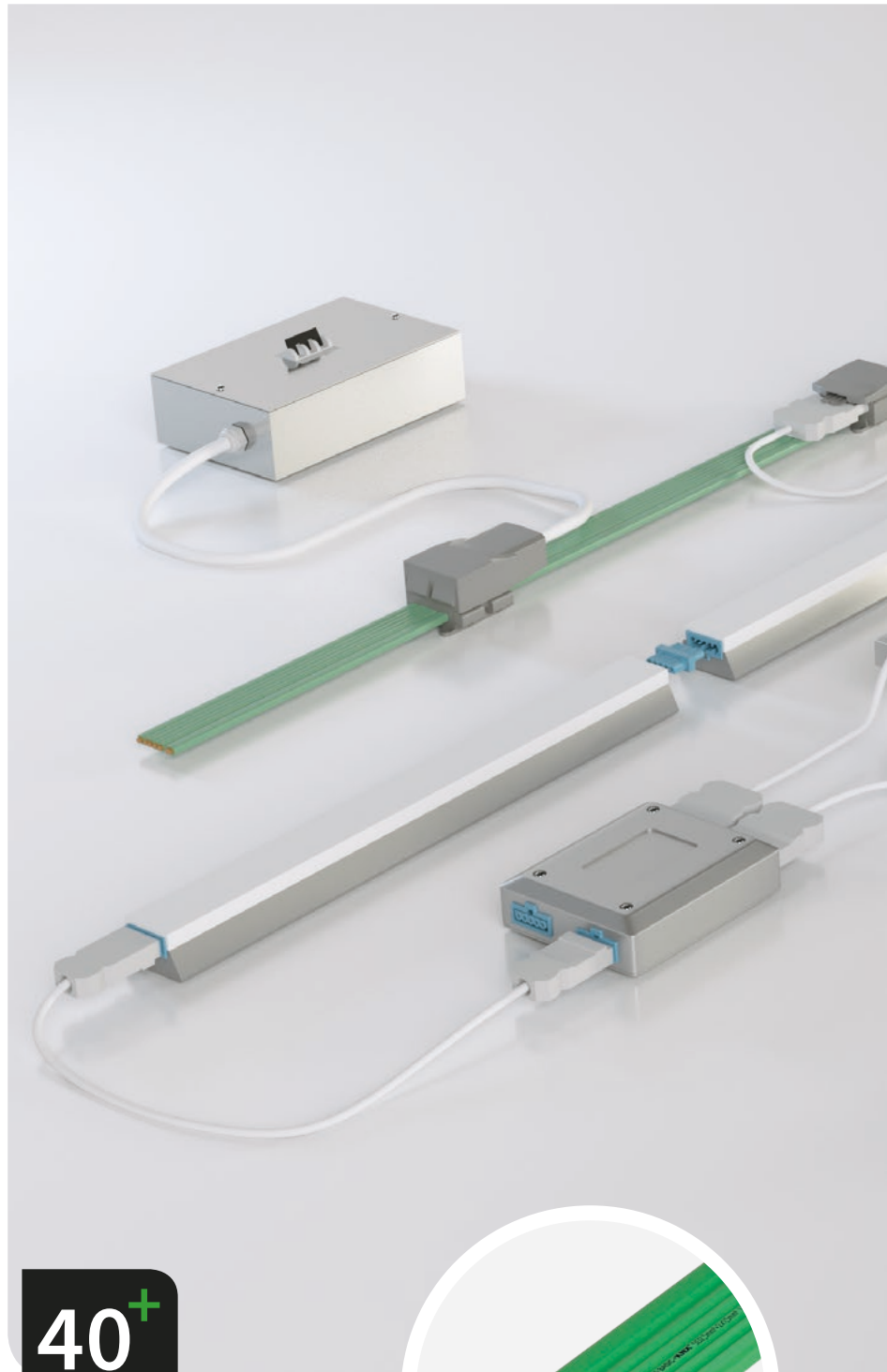

SYSTEM FEATURES

- ▶ Flexible & modular
- ▶ Extendable & retrofittable
- ▶ Resource-efficient
- ▶ Reusable
- ▶ IP40

gesis®NRG

The flexible busbar
Space-saving and safe
Available in various models.



gesis®CLASSIC

The all-rounder with the broadest portfolio

3- to 6-pole models,
250 V/400 V, 16 A/20 A



gesis®MINI

The little high-performer

2- to 5-pole models,
250 V/400 V, 16 A



gesis®MICRO

The inconspicuous space-saver in miniature

2- and 3-pole models,
50 V/250 V, 6 A/2.5 A

RST® SMART EFFICIENT OUTDOOR

Our RST® round connectors have been specially designed for efficient, pluggable, and moisture-proof electrical installation outdoors. In areas with high humidity in particular, such as industrial areas, parking garages, and greenhouses, stringent demands are placed on cabling and power supply to electrical consumers in terms of safety and flexibility.

RST® pluggable connectors withstand constant temperature changes, high UV radiation, high ozone values, and, not least, mechanical wear, which often lead to material fatigue, water ingress, and ultimately system failure.

Selecting suitable cables ensures that your installation will continue to operate safely.

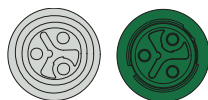

SMART CODING

Our color and mechanical coding applied in the factory makes plugging safe, very easy, and error-free.

SYSTEM FEATURES

- ▶ IP66/68 (3 m; 2 h)
- ▶ IP69
- ▶ With >Internal Water Stop<
- ▶ Flexible & modular
- ▶ Extendable & retrofittable
- ▶ Resource-efficient
- ▶ Reusable



RST® CLASSIC

All-rounder with the
broadest portfolio

2- to 7-pole models,
250 V/400 V, 20 A/32 A



RST® MINI

Small connector for extremely
confined spaces

2- to 5-pole models,
250 V/400 V, 16 A



RST® MICRO

Miniature connector with
maximum IP protection

2- and 3-pole models,
250 V/400 V, 8 A

RECESSED LUMINAIRES + PANEL LUMINAIRES

Our solution for recessed and lay-in luminaires: pluggable luminaires and components for the structured electrical installation of power and signals. DALI luminaires use the 5-pole plug system in order to operate the luminaire itself as well as the corresponding control components with a single connection (mains + signal).



PANEL LUMINAIRE

Pluggable connection integrated into the luminaire: gesis® (GST18®) Snap-In for connecting pre-assembled cables.

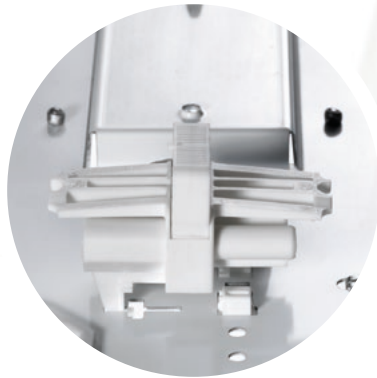

RECESSED LUMINAIRE

Freedom of choice with connection: recessed luminaires with BJB luminaire terminal block can easily be upgraded to a pluggable luminaire with gesis®TOP.

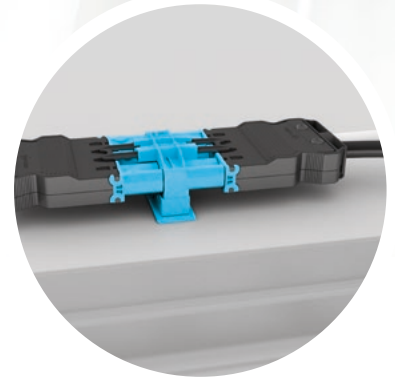

DIMMABLE RECESSED LUMINAIRE

Freedom of choice for dimmable luminaires: 5-pole connection for mains + dimming signal (e.g. DALI). Pastel blue coding.



APPLICATIONS

The electrical connection of recessed luminaires usually calls for the time-consuming method of opening the luminaire, dismantling and stripping the power supply and control cable, and, if applicable, inserting the illuminants on site. With pluggable pre-assembled luminaires, the effort required for on-site assembly can be reduced quite considerably.



SOLUTIONS

- Industrially pre-assembled components.
- Easy to plug together on site.
- For mains application (3-pole) and DALI application (5-pole).
- Flexibility to the point in time of luminaire assembly: conventional connection or pluggable with gesis®TOP.



ADVANTAGES

- Fast, easy, and safe installation.
- Standardized interfaces for fast replacement.
- High functional reliability through prevention of mismatching.
- Simple adjustment of the installation to local conditions.



COHESIVE PLUG SYSTEM

For distribution and luminaire connection with gesis®CLASSIC, gesis®MINI, gesis®MICRO.

DOWNLIGHTS SPOTLIGHTS + DRIVERS



DOWNLIGHT WITH DRIVER

Driver for downlight with integrated pluggable mains connection gesis®CLASSIC.

DOWNLIGHT WITH SEPARATE DRIVER

The pluggable interface gesis®MICRO (GST08i2) between electronic ballast and downlight enables quick installation on site and reduces inventory.

PC BOARD TERMINALS

For a convenient connection between LED drivers and building installation, and for a maintenance-friendly connection between driver and LED module, we offer printed circuit board male connectors and female connectors: wie-con® (7060 SMD, 8562 TOP H, 8562 N).



APPLICATIONS

For connecting downlights and recessed spotlights, whether with integrated or with separate ballast. The distinction between the primary circuit (230 V) and the connection between the ballast or driver and the luminaire (constant voltage 12...24 V/constant current 350...1,500 mA) and the use of different connector systems or codings prevent any confusion of circuits. Installation is error-free and easy.



SOLUTIONS

- Industrially pre-assembled components.
- gesis®CLASSIC (GST18®) for mains voltage.
- gesis®MICRO (GST08), ST16, LST03 for the secondary circuit.
- Easy to plug together on site.
- Easy replacement of faulty ballasts due to pluggable interface.



ADVANTAGES

- Fast, easy, and safe installation.
- Standardized interfaces for fast replacement.
- High functional reliability through prevention of mismatching.
- Easy function test for all components using pluggable test adapters.



COHESIVE PLUG SYSTEM

For distribution, luminaire connection, and as an interface between electronic ballast and luminaire: gesis®CLASSIC, gesis®MICRO, wiecon®.

UNDER-SHELF LUMINAIRES + PENDANT LUMINAIRES + LIGHTING SYSTEMS



UNDER-SHELF LUMINAIRE

geis®MICRO (GST08) for front-sided connection of luminaire to separate LED driver. Distribution elements can be used to connect several luminaires, e.g. for shelf lighting.

PENDANT LUMINAIRE

geis®MICRO (GST08) for connecting pendant luminaires. The free end is connected in the canopy. Or as an exterior connecting cable to connect two luminaires to each other flexibly.

LIGHTING SYSTEM

geis®MINI (GST15) 5-pole for internal three-phase current wiring and as transition to the front of the luminaire.



APPLICATIONS

Pendant luminaires, strip lighting luminaires, and under-shelf luminaires require specific systems for electrical connection and through-wiring. The power and signal supply is usually from one side and is continued internally in the strip light. To achieve maximum prefabrication, smart, pluggable solutions are required both for the assembly and for the electrical connection.



SOLUTIONS

- gesis®CLASSIC (GST18®) for three-phase current wiring up to 20 A and with double tap.
- gesis®MINI 5-pole (three-phase current) or 5-pole (230 V + signals) for optimal space.
- gesis®MICRO the smallest mains connector for pendant and under-shelf luminaires.
- Harmonized snap-in elements and lighting system connectors.



ADVANTAGES

- Fast, easy, and safe installation.
- For more than 40 years: robust quality for every requirement.
- High functional reliability through prevention of mismatching.
- The right product for through-wiring up to 4.0 mm² (gesis®CLASSIC).



COHESIVE PLUG SYSTEM

For distribution, luminaire connection, and as a strip lighting connector: gesis®CLASSIC, gesis®MINI, gesis®MICRO.

INDUSTRIAL LUMINAIRES



HIGHBAY LUMINAIRES

Quick connection of highbay luminaires without opening the housing with RST®MINI. The assembly time is reduced to 20 %, and the IP protection of the luminaire is preserved.



PARKING GARAGE LIGHTING

Quick retrofitting of parking garages with energy-efficient LED lighting using the pluggable luminaire connector RST®MINI. Pre-assembled cables are inserted into the cable ducts; pluggable distribution elements are attached to the cable duct.



MOISTURE-PROOF LUMINAIRE

RST®CLASSIC pluggable connector to luminaires with higher protection rating for quick and safe assembly without opening the luminaire.



COHESIVE PLUG SYSTEM

Distribution elements and pre-assembled cables for outdoor use and for all applications with a higher protection rating (IP66...68). RST®CLASSIC (RST20): 20 A
RST®MINI (RST16): 16 A



APPLICATIONS

RST® will end your search for the right solution for industrial electrical installation. The connector system, with protection rating IP66/IP68, is also suitable for temporary full immersion. Moisture-proof luminaires can be assembled and connected quickly and easily without being opened.



SOLUTIONS

- RST®MINI for the electrical connection of highbay luminaires.
- RST®MINI 5-pole plugs for dimmable LED luminaires – light where and how it is needed!
- RST®CLASSIC device connectors, ready-to-use cable assemblies, and distribution elements for flexible installation in the IP range.
- RST®MINI for pluggable damp-proof luminaires.



ADVANTAGES

- Fast, easy, and safe installation.
- For more than 40 years: robust quality for every requirement.
- High functional reliability through prevention of mismatching.
- The right product for through-wiring up to 4.0 mm².

STREET LIGHTS + **OUTDOOR** LUMINAIRES



STREET LIGHTS

Connector in luminaire pole for connection and maintenance (programming): RST®CLASSIC (RST20).



ROAD LIGHTING

Safe and durable electrical installation in luminaires for roads: RST®CLASSIC (RST20) connector.



OUTDOOR LUMINAIRES

Smart installation for outdoor use without opening the luminaire. The IP rating is preserved at all times. Pre-assembled as pluggable and sealed for life with RST®CLASSIC (RST20).



APPLICATIONS

With RST® we offer the right solution for all luminaires used outdoors and in industry. The connector system, with protection rating IP66/IP68/IP69, is also suitable for brief full immersion.

As an interface to moisture-proof luminaires, it offers the advantage that the luminaire no longer has to be opened for the electrical installation.



SOLUTIONS

- RST® for modular street lights.
- RST® 5-pole service pluggable interface for programming DALI dimmable luminaires.
- RST® device connectors, ready-to-use cable assemblies, and distribution elements for flexible outdoor installation.



ADVANTAGES

- Fast, easy, and safe installation.
- High functional reliability through prevention of mismatching.
- Easy function test without opening the luminaire.
- Installation without limitation of warranty – the luminaire retains its IP protection through to installation.
- Broad system – the perfect product for every application in terms of number of poles, coding, dimensions, and design.



OUTDOORS

Electrical installations outdoors, such as illuminated advertising, security systems, etc.



ARCHITECTURAL + EVENT + GARDEN LIGHTING

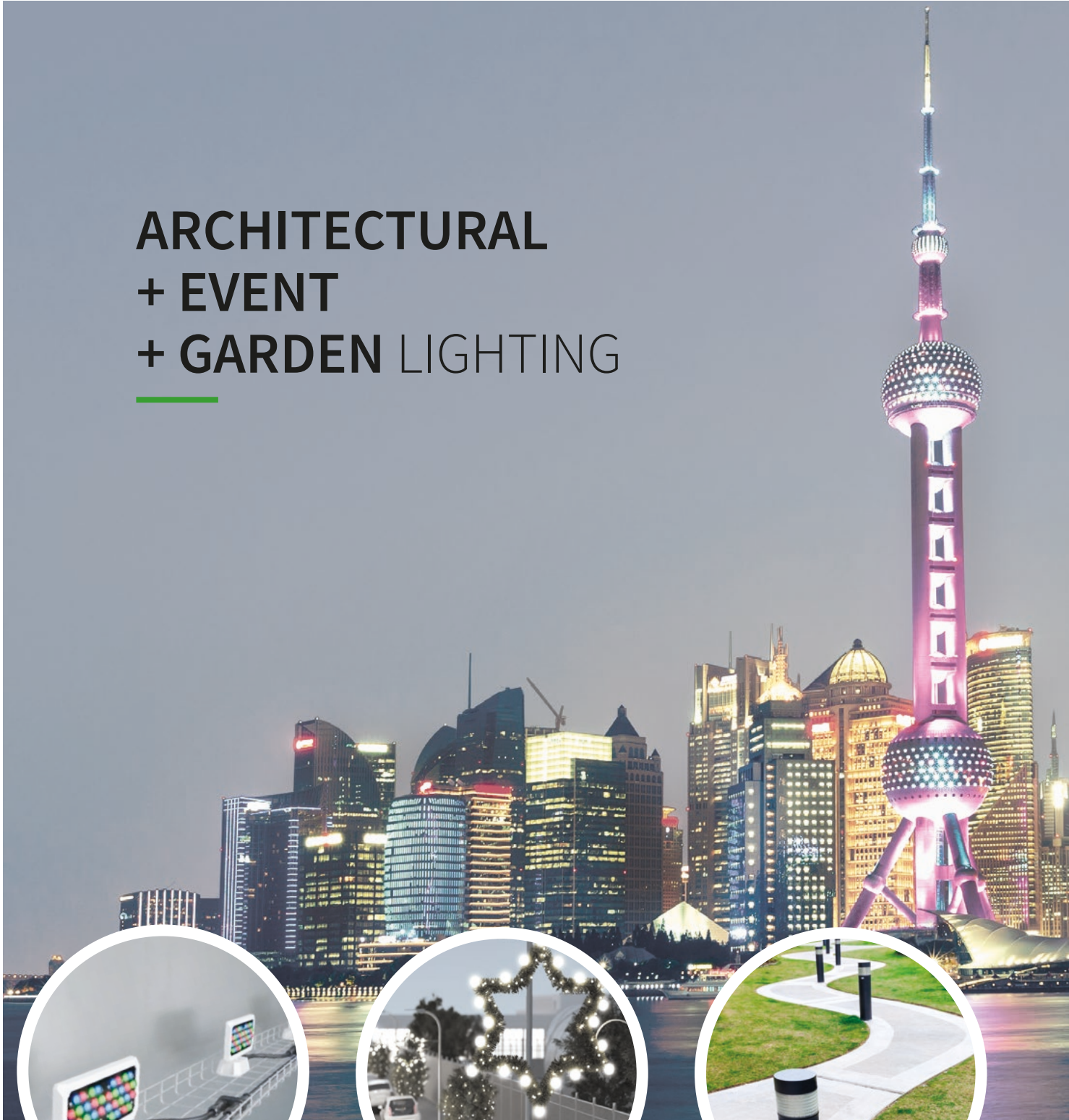

ARCHITECTURAL LIGHTING

Maintenance-friendly and flexible façade lighting is pluggable by design. RST®CLASSIC (RST20)

EVENT LIGHTING

Temporary lighting installations for events and seasonal decoration: pre-assembled and pluggable with RST®CLASSIC (RST20).

OUTDOOR LIGHTING

Safe and durable electrical installation for outdoor lighting. RST®MINI



APPLICATIONS

With the RST® connector system we offer the complete infrastructure for architectural lighting installed in façades, for event lighting that is erected and dismantled quickly (from Christmas lights to giant posters), and for safe garden and outdoor lighting.

With connectors, device connectors, cable assemblies, and distribution elements we provide the complete infrastructure to supply luminaires with power (mains voltage 230 V/400 V, low voltage) and data (DALI, KNX, DMX etc.).



SOLUTIONS

- RST®CLASSIC (RST20) for three-phase current wiring up to 20 A and with double tap.
- RST®MINI 5-pole (three-phase current) or 5-pole (230 V + signals) for optimal space.
- RST®MICRO the smallest mains connector for inconspicuous garden installation.
- Protection against unintentional loosening of the connections.



ADVANTAGES

- Fast, easy, and safe installation.
- High functional reliability through prevention of mismatching.
- Easy function test without opening the luminaire.
- Installation without limitation of warranty – the luminaire retains its IP protection through to installation.
- Broad system – the perfect product for every application in terms of number of poles, coding, dimensions, and design.



GARDEN LIGHTING

Impressive, pluggable lighting for gardening and landscaping. Unobtrusive cabling as well as safe distribution and separation of power circuits for outdoor use included. RST®MICRO

COHESIVE PLUG SYSTEM

Connectors

for power supply to the connector system

Device connectors

are integrated directly into terminals and form the interface to the connector system

Cable assemblies

for transmission and supply of electrical energy or signals

Distribution blocks

for distributing electrical energy or signals within the network

TECHNICAL DATA

Number of poles

Rated current

Rated voltage

Connector cross section

Protection rating

Codings

Standards

Certificates / approvals

gesis®CLASSIC | GST18®



gesis®CLASSIC | GST18®

3 to 6-pole

20 A

250 V/400 V

0.75...4.0 mm²

IP20/40

● O Mains voltage

● Non-SELV (dimming)

● Low voltage

● Switching

EN 60598

EN 61535



APPLICATIONS

- Recessed luminaires
- Floor lamps
- Street lights
- Connection between electronic ballast/driver and luminaire



INDOOR

gesis®MINI | GST15

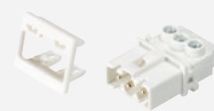

gesis®MINI | GST15

2 to 5-pole

16 A

250 V/400 V

0.5...2.5 mm²

IP20/40

● O Mains voltage

● Non-SELV (dimming)

● Low voltage

● Switching

EN 60598

EN 61535



APPLICATIONS

- Recessed luminaires
- Downlights
- Strip lighting luminaires
- Pendant luminaires
- Internal luminaire wiring
- Connection between electronic ballast/driver and luminaire



Our E-SHOP

Scan QR code – view products directly in the E-SHOP.



OUTDOOR

gesis®MICRO | GST08



gesis®MICRO | GST08

- 2 to 3-pole
- 2.5 A/6 A
- 250 V/50 V
- 0.5...0.75 mm²
- IP20/40
- Mains voltage
- Low voltage (12 V)
- Low voltage (24 V)
- Constant current
- EN 61984
- Mains volt: EN 60320
-

APPLICATIONS

- Recessed luminaires
- Downlights
- Pendant luminaires
- Under-shelf luminaires
- Internal luminaire wiring
- Connection between electronic ballast/driver and luminaire



RST®CLASSIC | RST20



RST®CLASSIC | RST20

- 2 to 7-pole
- 20 A/32 A
- 250 V/400 V
- 0.5...6 mm²
- IP66, IP68 (3m; 2h), IP69
- Mains voltage
- 250 V/400 V without PE
- Low voltage
- Non-SELV (dimming)
- IEC 61535
- IEC EX Zone 2, 22



APPLICATIONS

- Street lights
- Industrial hall luminaires (incl. ATEX/IECEX)
- Damp-proof luminaires
- Greenhouse lighting
- Decorative outdoor luminaires
- Connection between electronic ballast/driver and luminaire



RST®MINI | RST16



RST®MINI | RST16

- 2 to 5-pole
- 16 A
- 250 V/400 V
- 0.25...1.5 mm² (2.5 mm²)
- IP66, IP68 (3m; 2h), IP69
- Mains voltage
- 250 V/400 V without PE
- Low voltage
- Non-SELV (dimming)
- IEC 61535



APPLICATIONS

- Industrial hall luminaires (incl. ATEX/IECEX)
- Damp-proof luminaires
- Greenhouse lighting
- Decorative outdoor luminaires
- Connection between electronic ballast/driver and luminaire



RST®MICRO | RST08



RST®MICRO | RST08

- 2 and 3-pole
- 8 A
- 250 V/400 V
- 0.25...0.75 mm²
- IP66, IP68 (3m; 2h), IP69
- Mains voltage
- 250 V/400 V without PE
- Low voltage
- DIN EN 61984



APPLICATIONS

- Damp-proof luminaires
- Decorative outdoor luminaires
- Connection between electronic ballast/driver and luminaire



PRINTED CIRCUIT BOARD TERMINALS FOR LED











Three innovative products for connecting your luminaires or devices quickly and safely using direct plug-in technology.

TECHNICAL DATA

Number of poles
Rated current
Rated voltage
Connector cross section
 AWG
Cable type

Wire strip length
Dimensions
 3-pole (LxWxH)
Certificates / approvals

INSIDE

	wiecon® 7060 SMD	wiecon® 8562 TOP H	wiecon® 8562 N
			
Number of poles	2 to 4-pole	2 to 12-pole	2 to 9-pole
Rated current	9 A	4 A	4 A
Rated voltage	320 V	250 V	250 V
Connector cross section	0.32...0.75 mm ²	0.5...1.5 mm ²	0.5...1.5 mm ²
AWG	22...18	20...16	20...16
Cable type	Solid, fine-stranded	Solid, fine-stranded (with cable end sleeve)	Solid, fine-stranded
Wire strip length	5.4 mm (+/- 0.2 mm)	8.0 mm (+/- 0.5 mm)	9.0 mm (+/- 1.0 mm)
Dimensions	7.8 x 8.2 x 4.1 mm	10.5 x 12.5 x 6.4 mm	10.5 x 12.0 x 13.3 mm
Certificates / approvals			
APPLICATIONS	<ul style="list-style-type: none"> • LED boards • ZHAGA modules • LED drivers • Suitable for robot wiring 	<ul style="list-style-type: none"> • LED drivers • Mains connection for flat assemblies 	<ul style="list-style-type: none"> • LED drivers • Mains connection can be disconnected again
			

Our E-SHOP
 Scan QR code – view products directly in the E-SHOP.

GESIS®PLAN

THE CONCEPTION TOOL



Architects and electrical planners cannot perform their jobs without software planning tools, especially when reliable information regarding project scope, scheduling, and cost estimates is required.

Wieland Electric offers the gesis®PLAN software for conception pluggable electrical installations with gesis®. This conception tool uses CAD building data to generate installation drafts as well as parts and price lists.

gesis®PLAN also independently checks the current load of cables and detects errors. The planner can locate them immediately in the detailed 3D views.

Request gesis®PLAN free of charge:
gesisplan@wieland-electric.com

IP RATINGS

Definition of IP ratings (DIN EN 60529-1)

1st digit		IP ratings against ingress of objects and contact		2nd digit		IP ratings against ingress of water	
IP	Example	IP ratings against ingress of objects and contact		IP ratings against ingress of water			
		Protection against contact	Protection against ingress of objects	Protection against ingress of water			
		0	No protection	No protection	0	No protection	
		1	Any large surface of the body (e.g. back of hand)	Large objects (> 50 mm in diameter)	1	Protection against vertically falling drops	
		2	Finger	Medium-sized objects (> 12 mm in diameter)	2	Protection against diagonally (up to 15°) falling water drops	
		3	Tools and wires (> 2.5 mm in diameter)	Small objects (> 2.5 mm in diameter)	3	Protection against spraying water up to 60° to the vertical	
		4	Tools and wires (> 1.0 mm in diameter)	Grain-shaped objects (> 12 mm in diameter)	4	Protection from splashing water from any direction	
		5	Complete protection against contact	Dust deposition	5	Protection against jet spray water	✓
		6	Complete protection against contact	Dust ingress	6	Protection against powerful water jets	✓
		7			7	Protection against temporary immersion in water	✓
		8			8	Protection against continuous immersion in water	✓
		9			9	Protection against high pressure, high temperature spray downs	✓

TECHNICAL STANDARDS + NOTES

The following standards apply to the electrical connections of luminaires:

VDE 0100

Low-voltage electrical installations

As technical luminaires tend mainly to be installed in buildings permanently, the installation instructions of DIN VDE 0100 (for luminaires part DIN VDE 0100-559 “Selection and erection of electrical equipment – luminaires and lighting systems”) are also relevant alongside the luminaire standard EN 60598-1.

EN 60598

Luminaires – Part 1: General requirements and tests (IEC 60598-1:2014)

Generally speaking, the standard allows the use of all connectors if they satisfy the safety-relevant requirements. The respective test center must then examine, on a case-by-case basis, whether all the relevant requirements are met.

The following requirements, among others, are examined:
Hazardous interchangeability; protection against electric shock and protection rating; mechanical interlock; ground wire; protection of the poles against short circuit; strain relief.

Section 5.2.16: Mobile luminaires require the use of installation connectors according to IEC 61535. Use of such installation connectors means that the above requirements are no longer checked. These connectors can therefore be used without any further testing.

► **Products of the GST18®, GST15, GST08, and ST16/17 series are available with cable cross sections of 1.0/0.75/0.5 mm².**

EN 61535

Installation couplers intended for permanent connection in fixed installations

This concerns installation connectors for permanent connection in indoor installation systems with a rated voltage of up to 500 V and a rated connection capacity of up to 10 mm².

These installation connectors are intended for installation by a specialist or trained person as the national installation instructions must also be observed for installation. The installation instructions allow the use of such installation connectors for the through-wiring of luminaires which are part of the fixed installation.

► **Products of the GST18®, GST15, RST20, and RST16 series satisfy this standard.**

VdS

Luminaires – Guidelines for preventing damage (VdS 2005 : 2014-03 (05))

This guideline of the Association of Property Insurers (Verband der Sachversicherer, VdS) is mainly aimed at qualified electricians and contains minimum requirements for avoiding or minimizing fire hazards.

Section 7.2.2.3 Connections makes explicit reference to the use of installation connectors according to DIN EN 61535.

In particular, it states that according to DIN EN 61535 installation connectors from only one manufacturer may be used throughout. Any mixing of connectors (female-male) is therefore not permitted: “To guarantee compatibility, (other) installation connectors may only be used if the system has been approved by the manufacturer.” (Paragraph 7.1.9)

► **When using GST, RST ... make sure you use original Wieland products – there are no third-party systems certified by us.**

OUR SERVICES + OFFERS

With our extensive range of services and servicing packages, we are a highly capable partner in the lighting industry. We will assist you worldwide with the conception, design, and realization of cost-effective lighting solutions that are easy to assemble. Our connector systems for indoor and outdoor use enable project planning and optimization of smart decentralized installation solutions for energy and data infrastructure.

WE ARE WITH YOU ALL THE WAY

- From the first idea through to concept development.
- From the connection concept through to the first samples.
- From integration of the 3D CAD data to documentation of the relevant approvals and delivery of complete installation concepts from a single source.

OUR SERVICES

- + CONCEPTION
- + SAMPLING
- + CALCULATION
- + OPTIMIZATION
- + REALIZATION
- + PRODUCTION
- + DELIVERY



APPLICATION VIDEOS

On our YouTube channel you will find numerous examples of applications for smart luminaire installations with pluggable solutions from Wieland.

Scan QR code – watch video on YouTube.



Office lighting



Shop lighting



Industrial lighting



Street lighting



Garden lighting

SAMPLE OF REFERENCES

We supply to and work for renowned companies in the lighting industry.

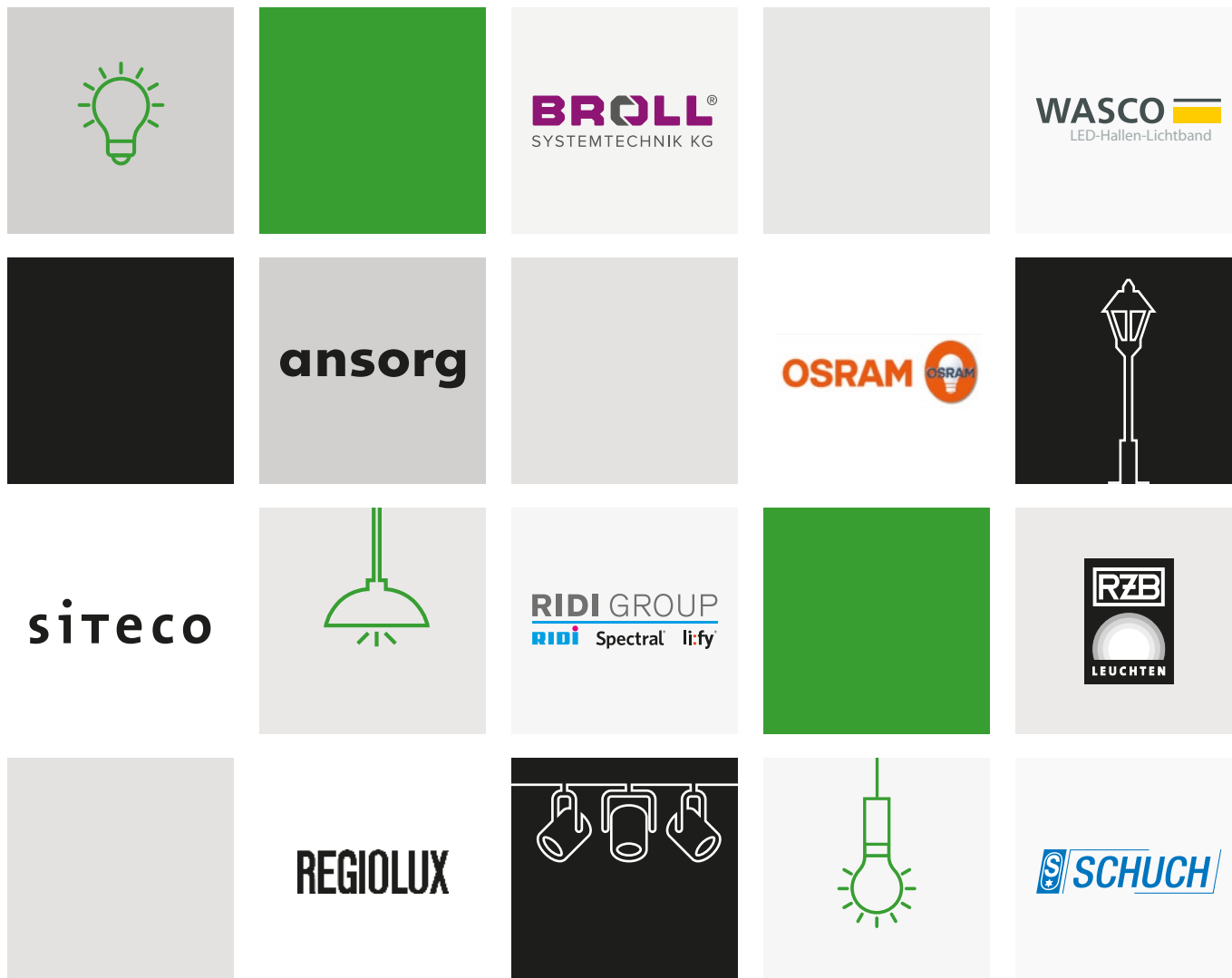

ABEL · ACUITY BRANDS · ADOLF SCHUCH · ALADIN · ALREC · ALTER · ANSORG · ANTARES · AQUA SIGNAL · ATENA · BROLL
CARANDINI · COMATELEC · COOPER · CORA · DESIGN 360 · DEXTRA · DHLICHT · DIETAL · DOCOM · DURLUM · DWD · EDGE LIGHTING
ES SYSTEM · ETAP · EWO · FAGERHULT · FEILO SYLVANIA · FOTODIASTASI · GERA-LEUCHTEN · GLAMOX · GLASHÜTTE · HELLUX · HESS
HOFFMEISTER · HOLOPHANE · IGUZZINI · INDALUX · INSTA · JUNG-LEUCHTEN · KEMMLER · KREON · LARSEN · LDBS · LENNEPER
LICHT & DESIGN · LICHTBASIS · LICHTSPIEL · LIGHT IN SHOP · LMT · LOUIS POULSEN · LTS · LUDWIG · LUG · LUMENPULSE · LUNOO
MAX FRANKE · MUNDOCOLOR · NEON FRANCE · NORDEON · NORKA · NORTH AMERICAN LIGHTING · OKTALITE · OSRAM · PANASONIC
PFEIFER + SEIBEL · PG LICHT · PRACHT · PHILIPS LIGHTING · PL LIGHT · PROLIGHT · RD LEUCHTEN · REGENT · REGGIANI · REGIOLUX
RESOLUX · RIDI · RUCO · RZB · SALDON · SAMMODE · SCHAHLLED · SCHRÉDER · SECURLITE · SITECO · SPECECLAIR · STAKO LUX
TARGETTI · THORN · THORPE · TRATO · TRAXON · TRILUX · VOSSLOH-SCHWABE · WASCO · WHITECROFT · WILA · WISKA · ZALUX · ZUMTOBEL



FROM US FOR YOU!
SERVICE FOR DEVELOPERS:
SAMPLES + SAMPLEBOARD

Our Sampleboard will give you an overview of the original components and key technical data throughout your product development phases; you will always have the right connector to hand and be able to access our electronic catalog with all the additional information and 3D data.

Order your product samples and a SAMPLEBOARD with wall hook.
Phone: +49 951 9324-996

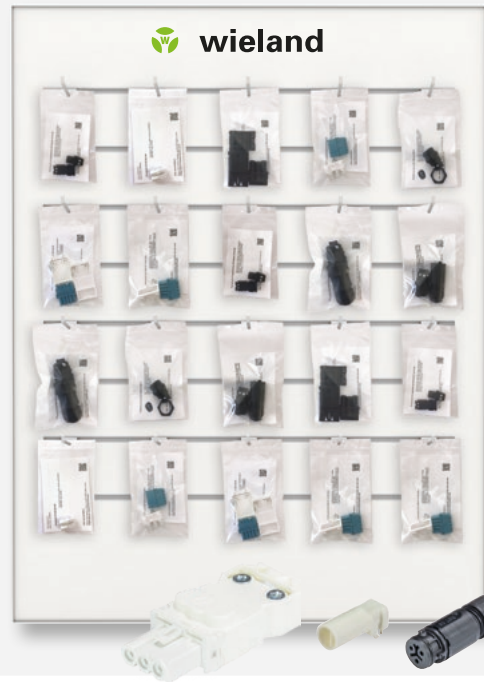

Wieland on YouTube
 See our solutions in motion



<https://www.youtube.com/user/WielandElectric>



Technical consultation
 Building Solutions

Email: building@wieland-electric.com

Worldwide: <https://wie.li/contactinternational>



ONLY ONE TAP AWAY

Our Wieland E-Shop
 Over 25,000 products - anytime

In our online store you will find all the information about our products, prices, and technical data.

Order easily and conveniently online, and check availability.

<https://eshop.wieland-electric.com>

Scan QR code – view products in the E-SHOP.





wieland

HEADQUARTERS

Wieland Electric GmbH
Brennerstraße 10 – 14
96052 Bamberg · Germany

Phone +49 951 9324-0
Fax +49 951 9324-198
info@wieland-electric.com

0429.1 MC 11/20

Represented in over 70 countries worldwide:

www.wieland-electric.com